

---

A WORLD OF ENCLOSURES

**iGlass**

**SHORT FOLDER**

[www.italtronic.com](http://www.italtronic.com)

---

**italtronic**  
enclosures for electronics







# HOME AUTOMATION new design collection

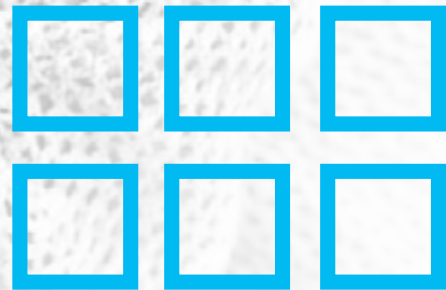

## SVILUPPATE LE VOSTRE IDEE USANDO LA PIATTAFORMA ELETTRONICA IGLASS

Italtronic propone una nuova linea di contenitori per HOME & BUILDING AUTOMATION.

## DEVELOPE YOUR IDEAS USING THE ELECTRONIC PLATFORM IGLASS

Italtronic offers a new line of enclosures for HOME & BUILDING AUTOMATION.

80.80 iGlass Serie/Series

80.120 iGlass Serie/Series

RETTANGOLARE 80.80/  
RIGHT ANGLE 80.80

Applicazione/  
Applications



RETTANGOLARE 80.120/  
RIGHT ANGLE 80.120

Applicazione/  
Applications

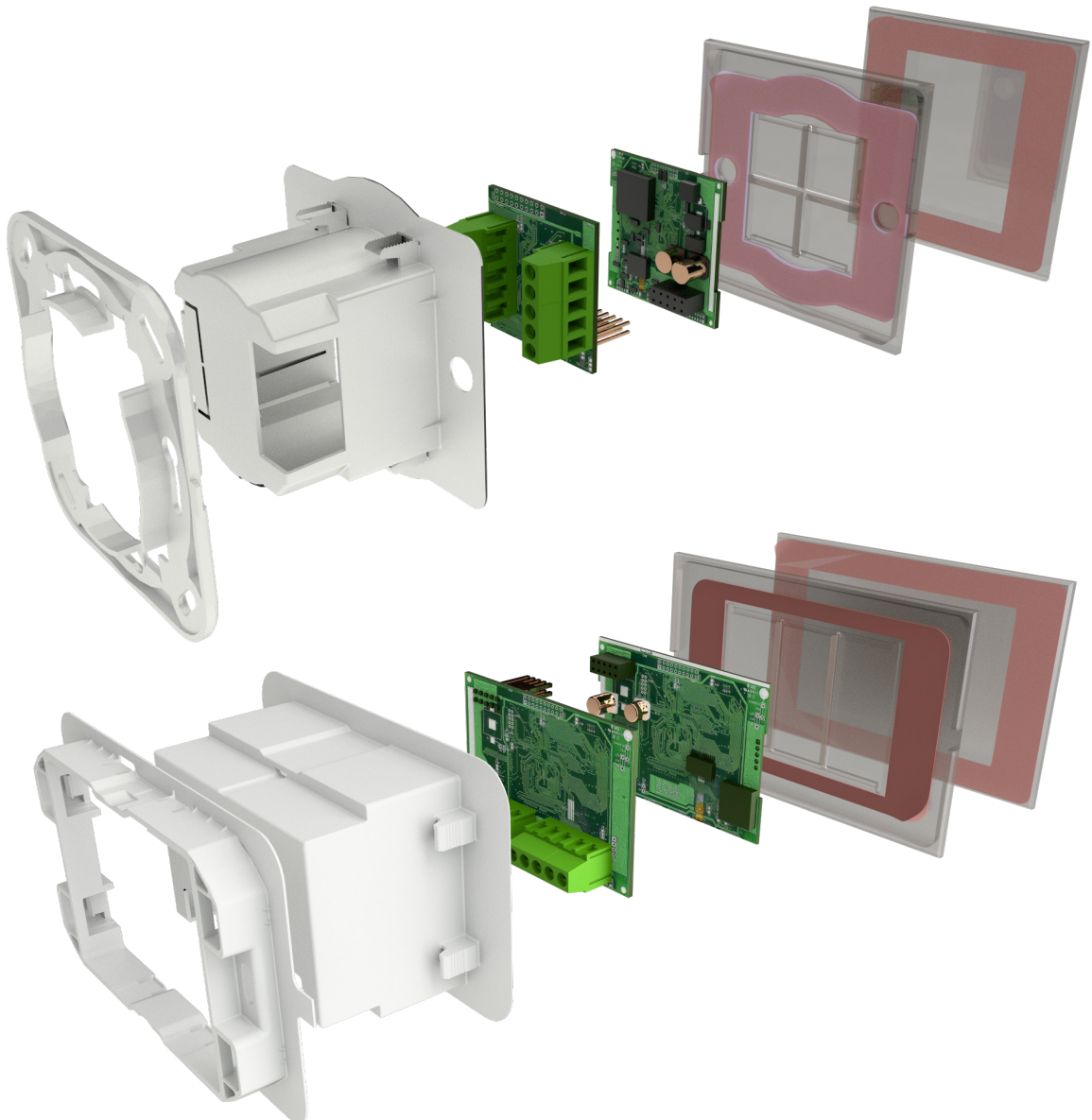
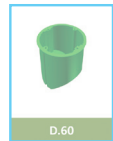

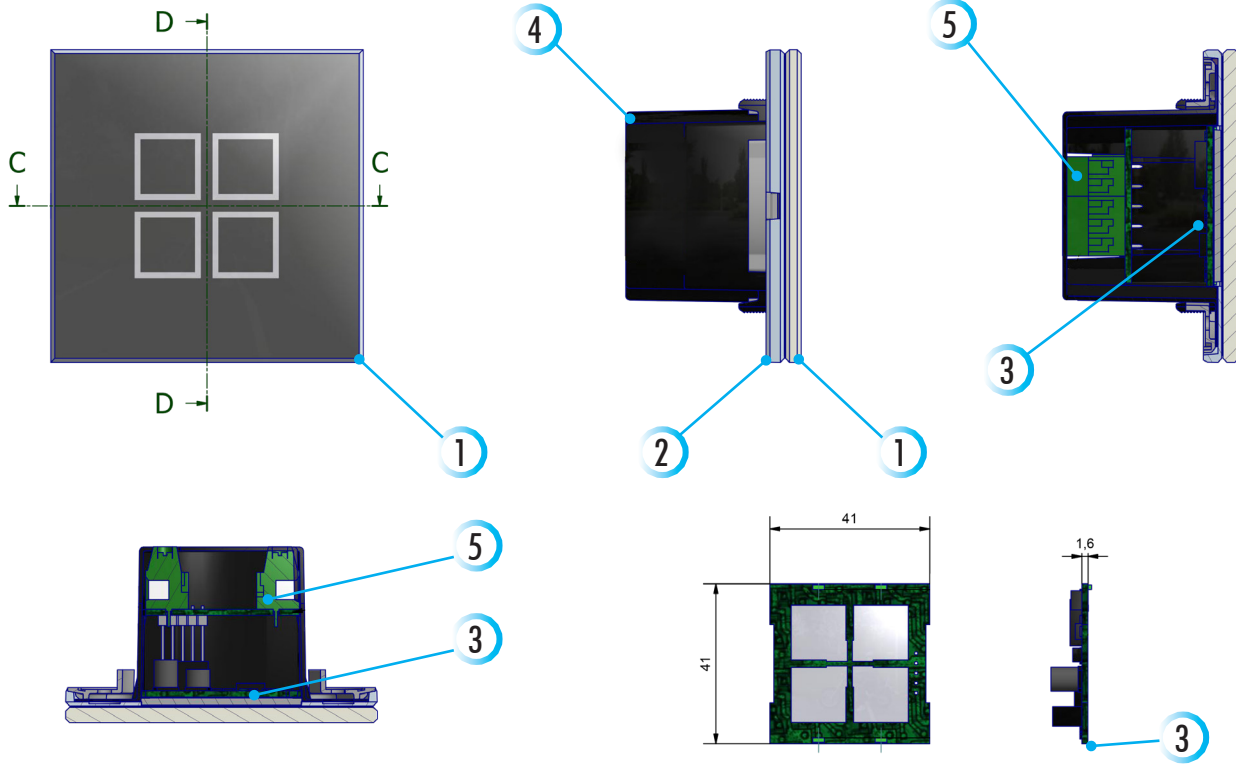

ENCLOSURE SYSTEM iGlass

80.120 iGlass Serie/Series

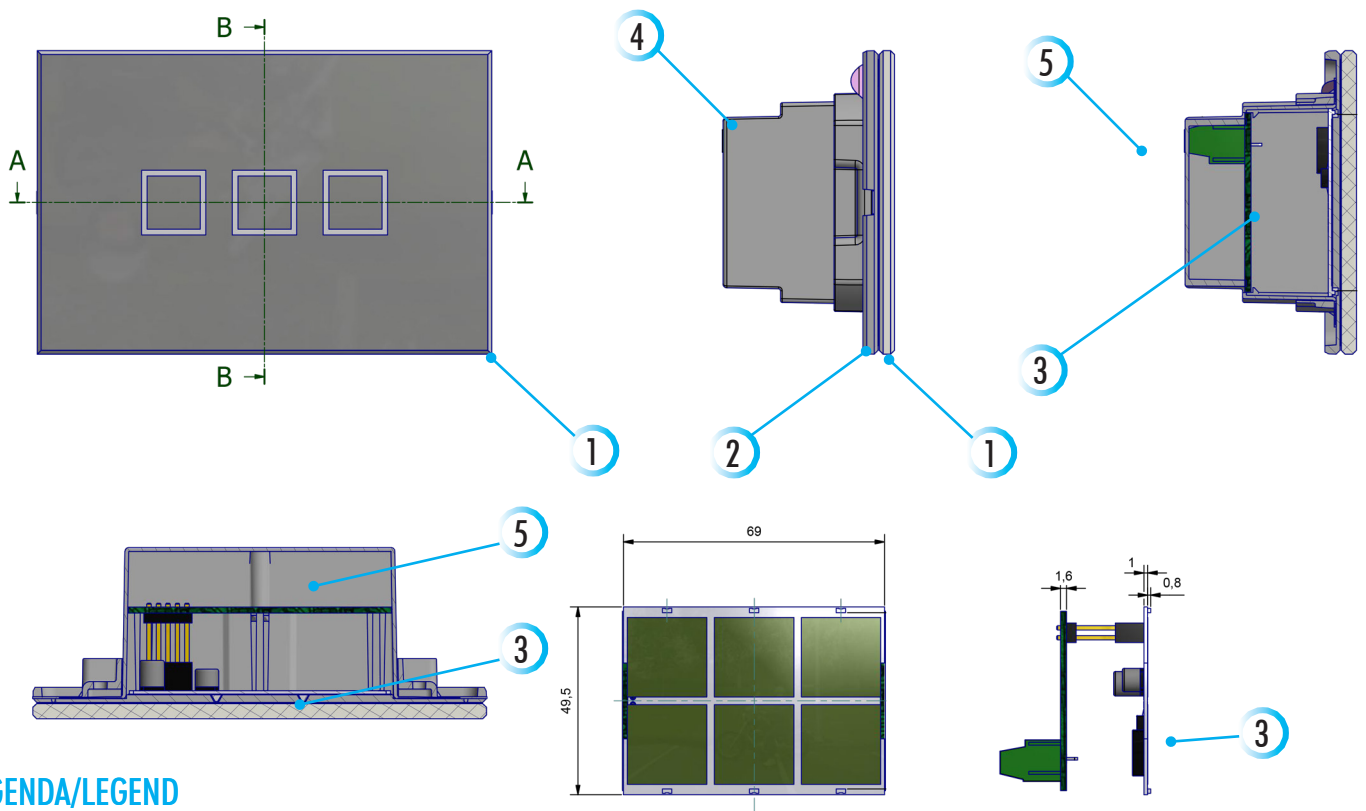

LEGENDA/LEGEND

- 1 Vetro/Glass
- 2 Supporto/Support
- 3 Scheda capacitiva/Capacitive board
- 4 Contenitore/Enclosure
- 5 Scheda interfaccia NON INCLUSA/Interface board NOT INCLUDED

80.80 iGlass Serie/Series

SWITCH/SLIDER

80.80 SWITCH\*

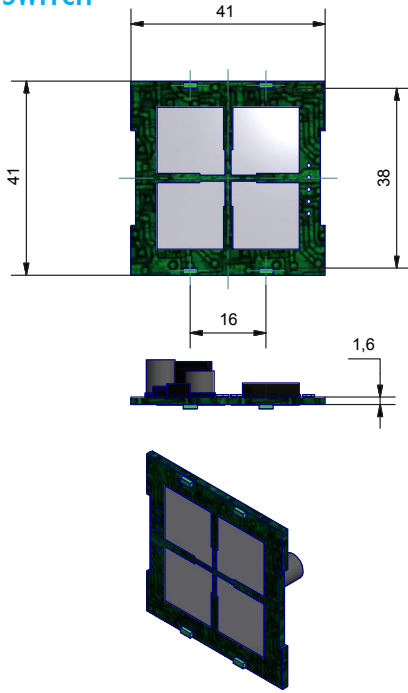

\* Versioni Speciali con sonde temperatura o umidità o altro su richiesta.

80.80 SLIDER\*

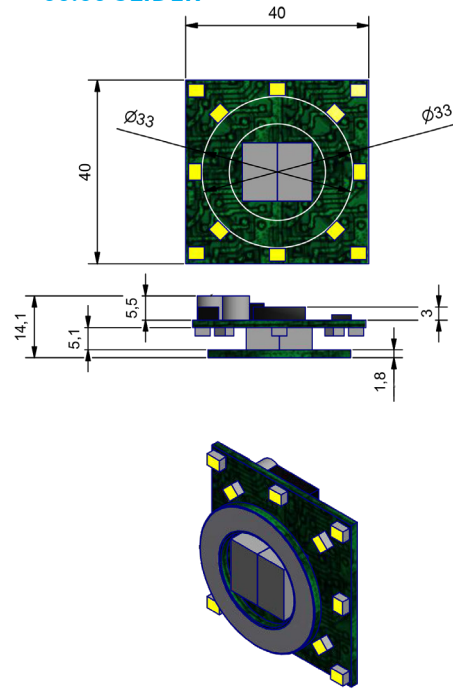

\* Special Version with temperature, humidity or others probe on demand.

80.80 SWITCH

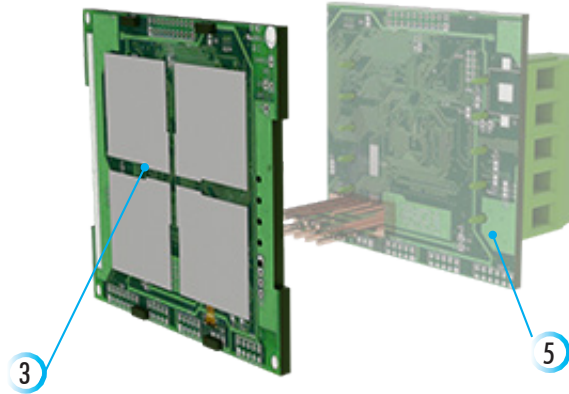

80.80 SLIDER

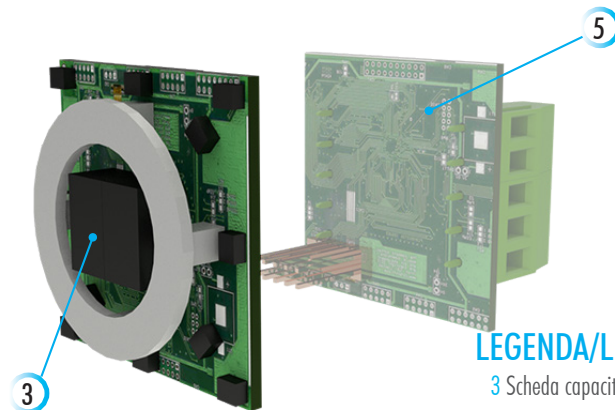

LEGENDA/LEGEND

- 3 Scheda capacitiva/Capacitive board
- 5 Scheda interfaccia/Interface board

80.120 SWITCH\*

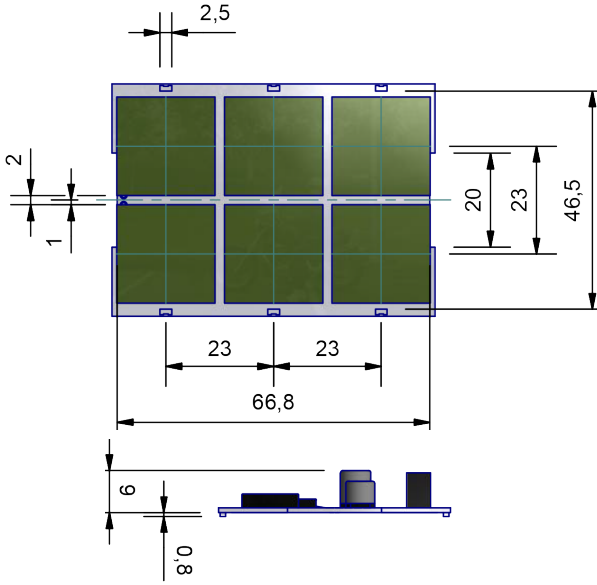

80.120 SLIDER\*

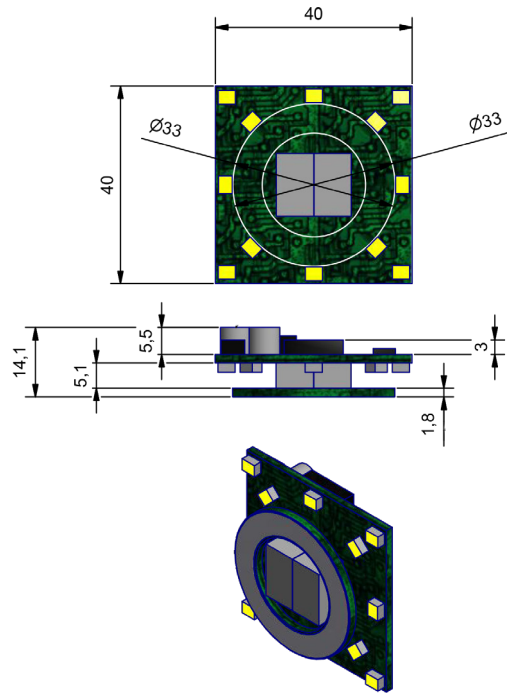

\* Versioni Speciali con sonde temperatura o umidità o altro su richiesta.

\* Special Version with temperature, humidity or others probe on demand.

80.120 SWITCH

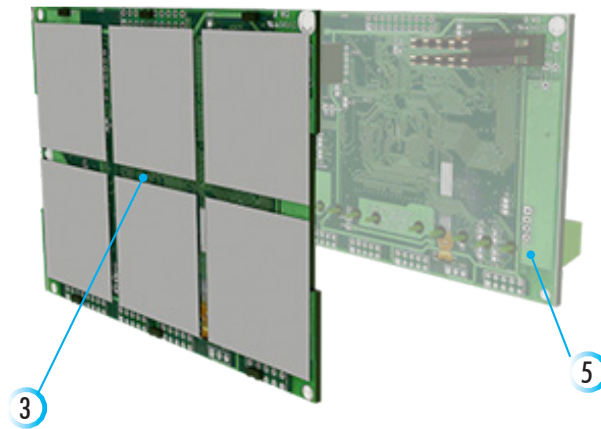

80.120 SLIDER

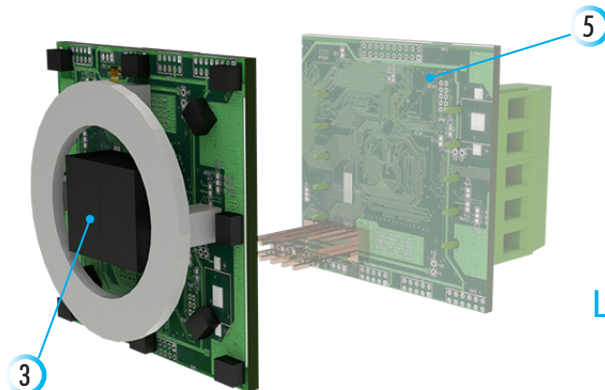

LEGENDA/LEGEND

3 Scheda capacitiva/Capacitive board

5 Scheda interfaccia/Interface board

# INTERFACE BOARDS iGlass

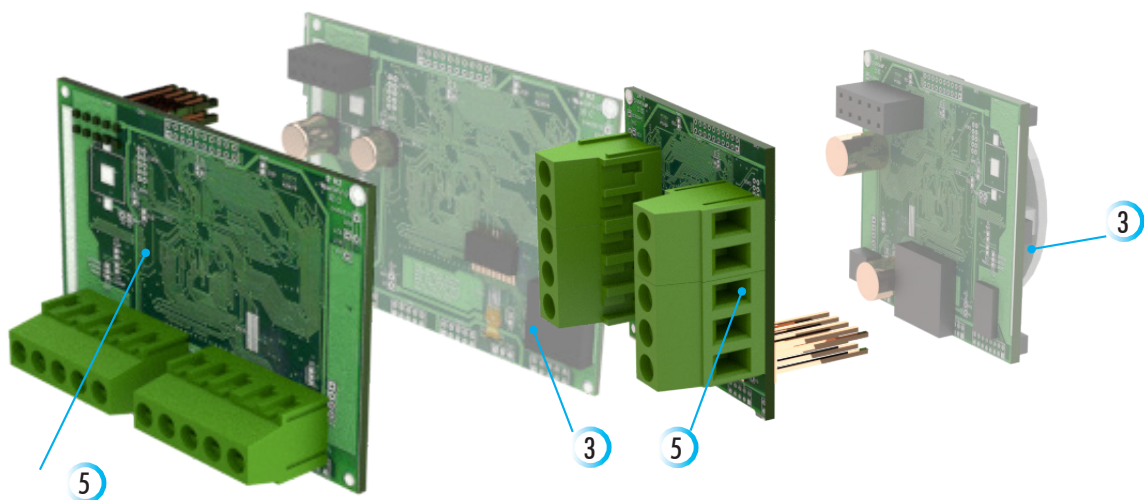
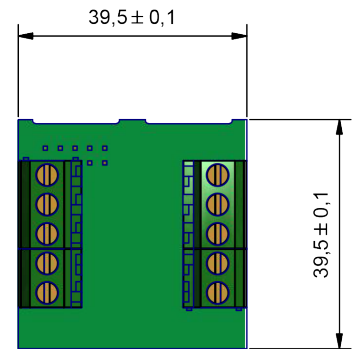
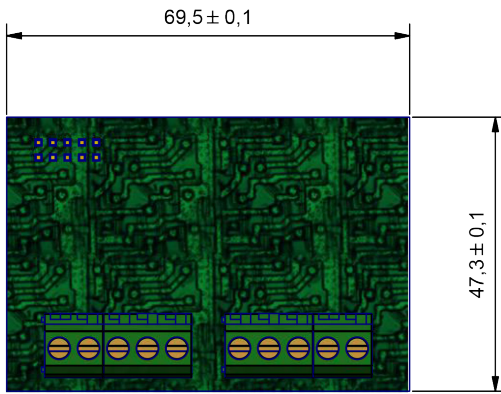
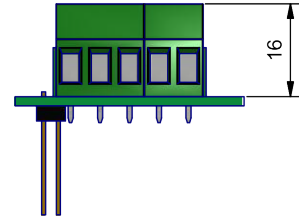
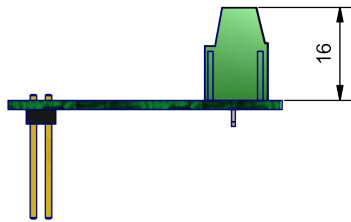
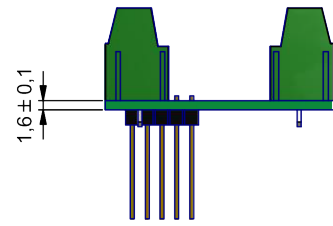
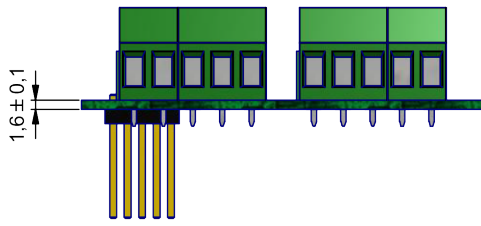

## LEGENDA/LEGEND

3 Scheda capacitiva/Capacitive board

5 Scheda interfaccia/Interface board



PRESA AXOLUTE 80.80/  
AXOLUTE PLUG 80.80

PRESA AXOLUTE 80.120/  
AXOLUTE PLUG 80.120

PLUGS iGlass

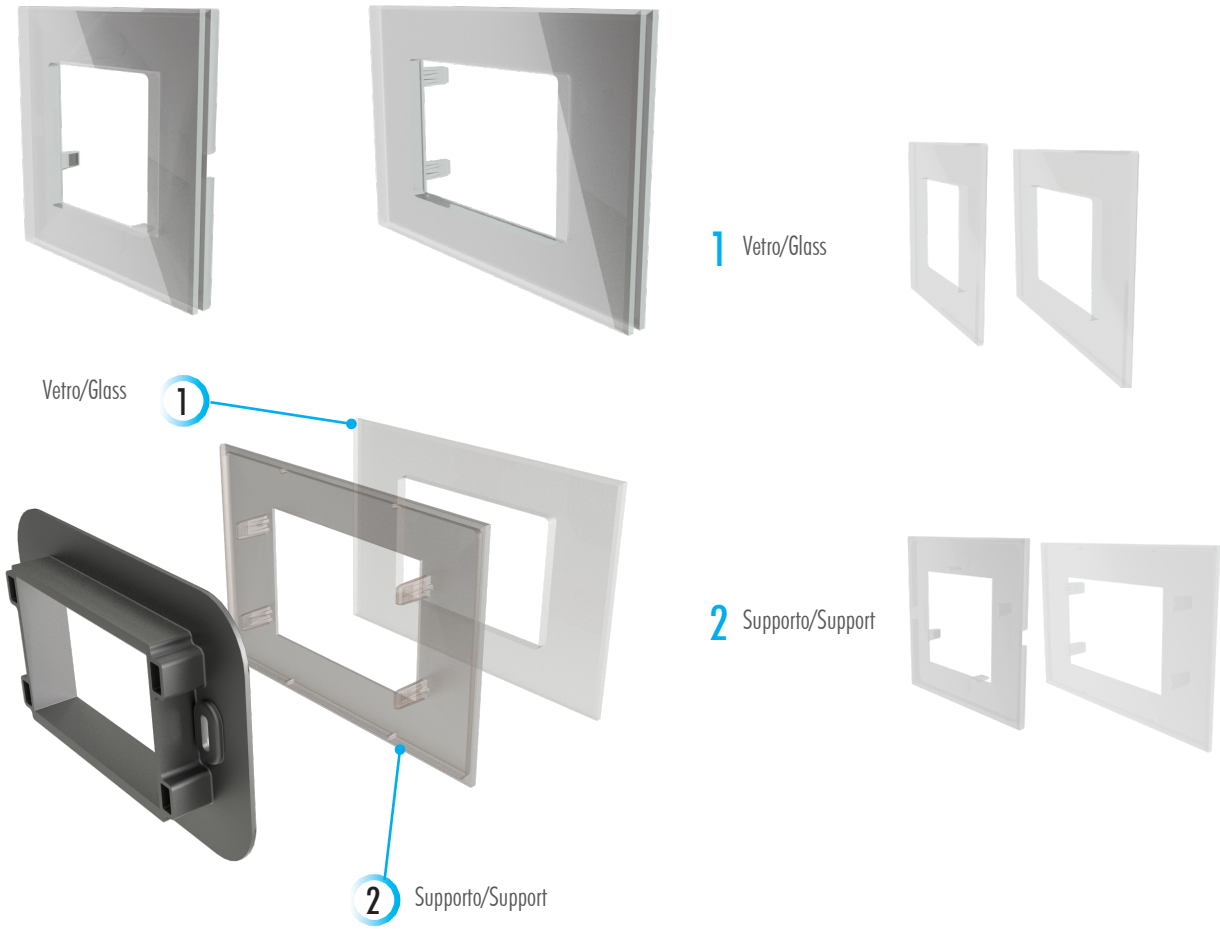

ASSEMBLAGGIO/ASSEMBLY

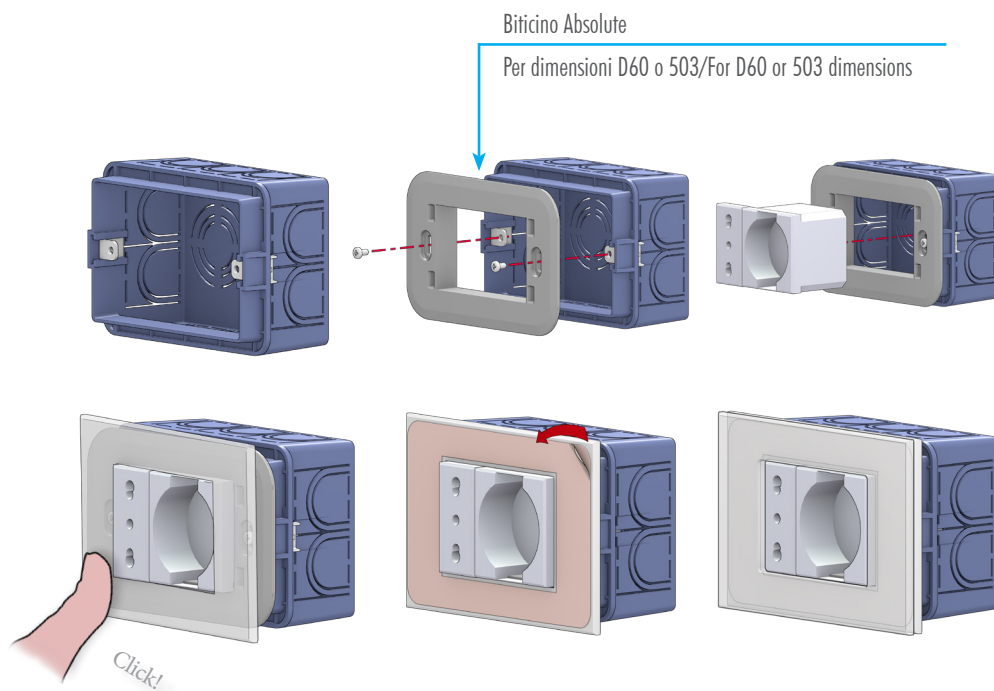

# PLUGS iGlass

80.80

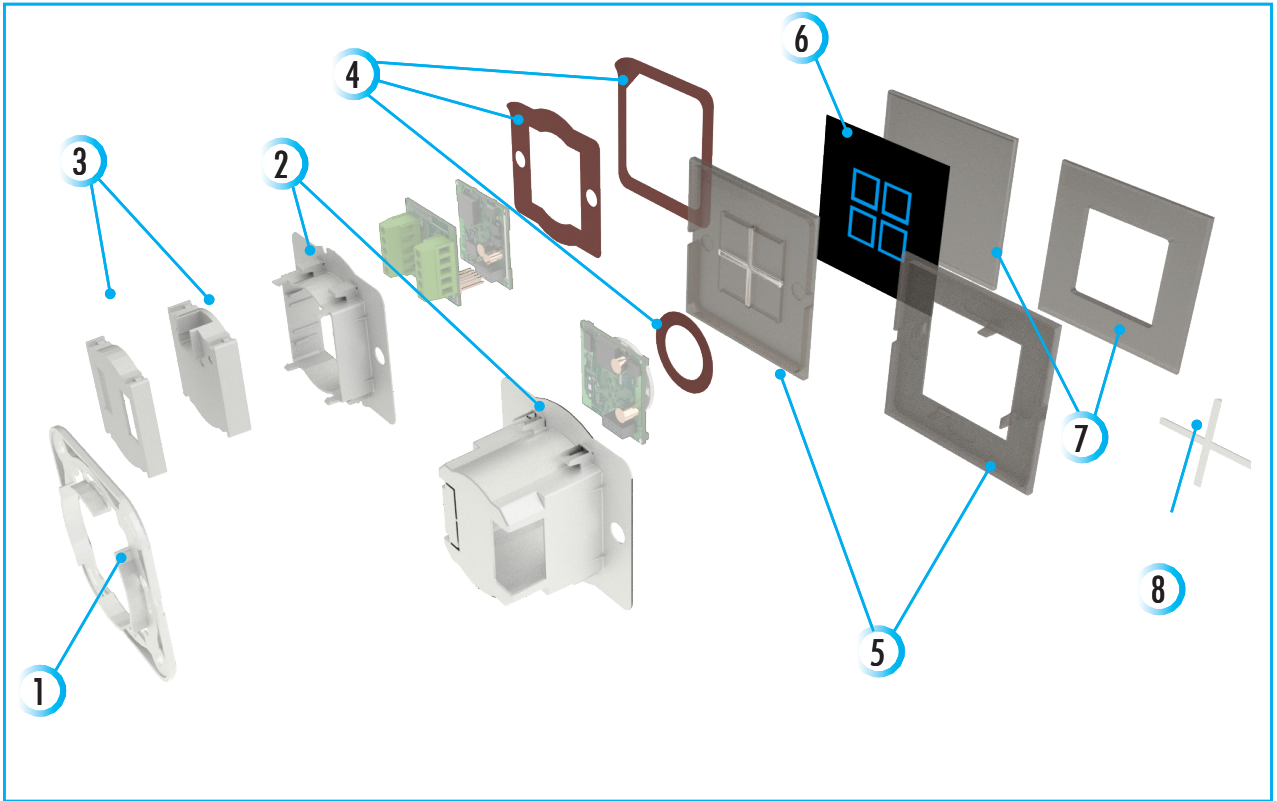

80.120

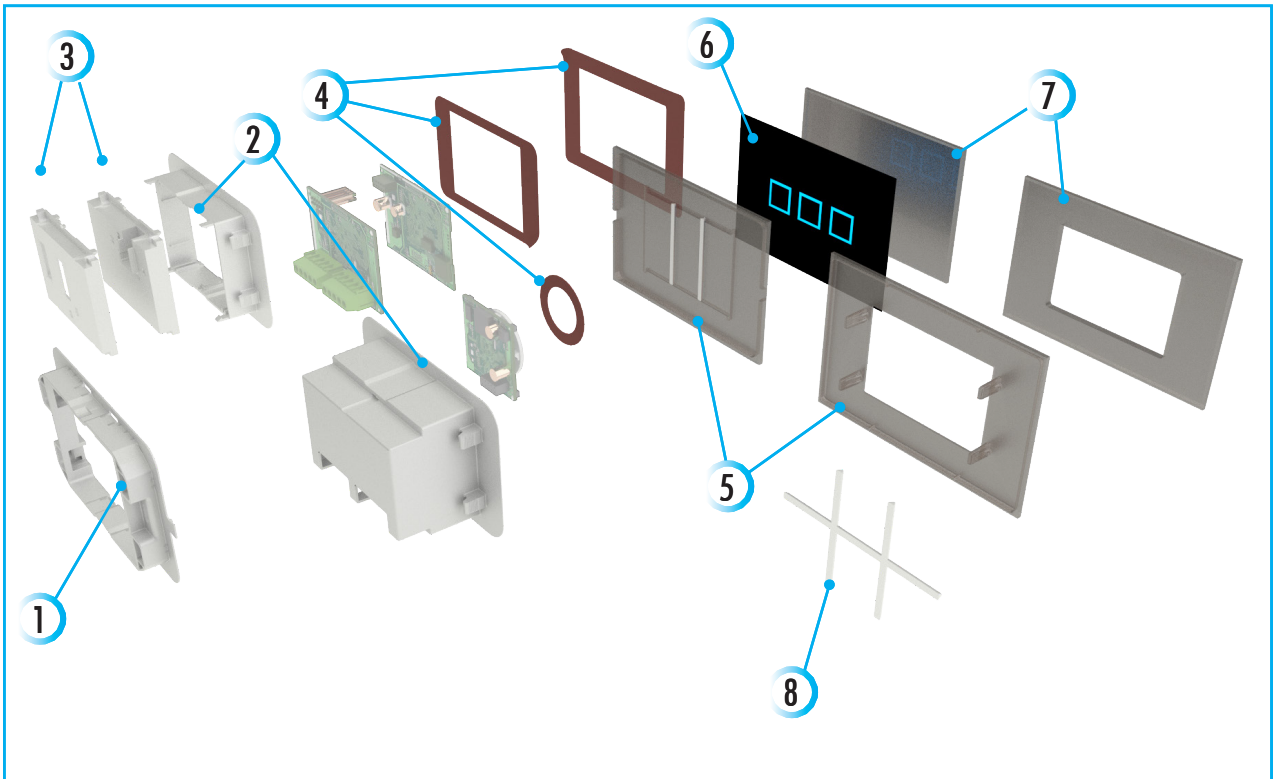

## LEGENDA/LEGEND

1. Cornice/Frame
2. Corpo contenitore/Body enclosure
3. Chiusura posteriore/Back cover
4. Biadesiva/Double sided adhesive
5. Supporto/Support
6. Stampa grafica/Graphic print
7. Vetro/Glass
8. Separatore/Separator

Vedi come scegliere gli accessori  
See how to choose the accessories

## SHORT FOLDER

### COME SCEGLIERE GLI ACCESSORI

1. Scelta della cornice di fissaggio: cercate nelle pagine successive del short Folder il codice corretto per questo primo particolare, non è difficile perché sono elencate solo due misure. La prima adatta al kit per vetro 80x80 mm e per fissaggio su Scatola elettrica da parete, diametro 60mm. La seconda adatta al kit vetro 120x80mm e per fissaggio su scatola rettangolare per 3 frutti (GANG)
2. Scelta del corpo contenitore: per ogni dimensione (80x120 oppure 80x80) sono previste 2 versioni: la prima è un unico contenitore altezza 30mm da incollare sul supporto (5) con biadesivo fornito, la seconda è la prima di due parti da incollare sul supporto sulla quale assemblare la seconda parte specializzata KNX oppure per Morsetti, denominata Chiusura posteriore da scegliere al passo 3.
3. Scelta della chiusura posteriore: la chiusura posteriore deve essere scelta in accordo con la dimensione del corpo contenitore (80x80 oppure 80x120) e con l'applicazione per cui si intende sviluppare il prodotto, KNX oppure con morsetti.
4. Scelta dei biadesivi: scegliere i due biadesivi necessari all'incollaggio della contenitore sul supporto e del vetro sul supporto, in accordo con le due misure 80x80 e 80x120. Per l'ancoraggio del vetro sul supporto per la copertura delle prese di tensione utilizzare il biadesivo per vetro. Acquistate anche il biadesivo circolare se intendete realizzare un dispositivo con elettronica con SLIDER circolare da adesivizzare direttamente sul vetro.
5. Scelta del supporto: scegliere il supporto in accordo con la dimensione (80x120 oppure 80x80) e con il numero di tasti che intendete ottenere oppure per la copertura delle prese di Tensione.
6. Inviatemi i files delle grafiche che volete realizzare sul Vetro per la nostra offerta. Nel Short folder sono rappresentate alcuni esempi con i relativi prezzi.
7. Scelta del Vetro: scegliere il vetro in accordo con la misura del supporto (80x80 oppure 80x120), inoltre scegliere il vetro completamente piatto per realizzare le vostre elettroniche con tasti, con apertura centrale per la le prese di tensione o, infine, con ribasso circolare per gli slider. I vetri sono forniti in versione trasparente senza alcuna personalizzazione grafica. La personalizzazione grafica può essere richiesta in accordo alla Vostra specifica oppure potete ordinare i vetri con nostra grafica standard come elencati nel short folder, che include prezzi e quantità minime.
8. Scelta del separatore per cross\_light: scegliere il separatore in accordo con la dimensione del vetro (80x80 oppure 80x120). Dovrà essere adattato prima dell'assemblaggio tagliando le parti eccedenti, in accordo con il numero dei tasti.

### HOW TO CHOOSE THE ACCESSORIES





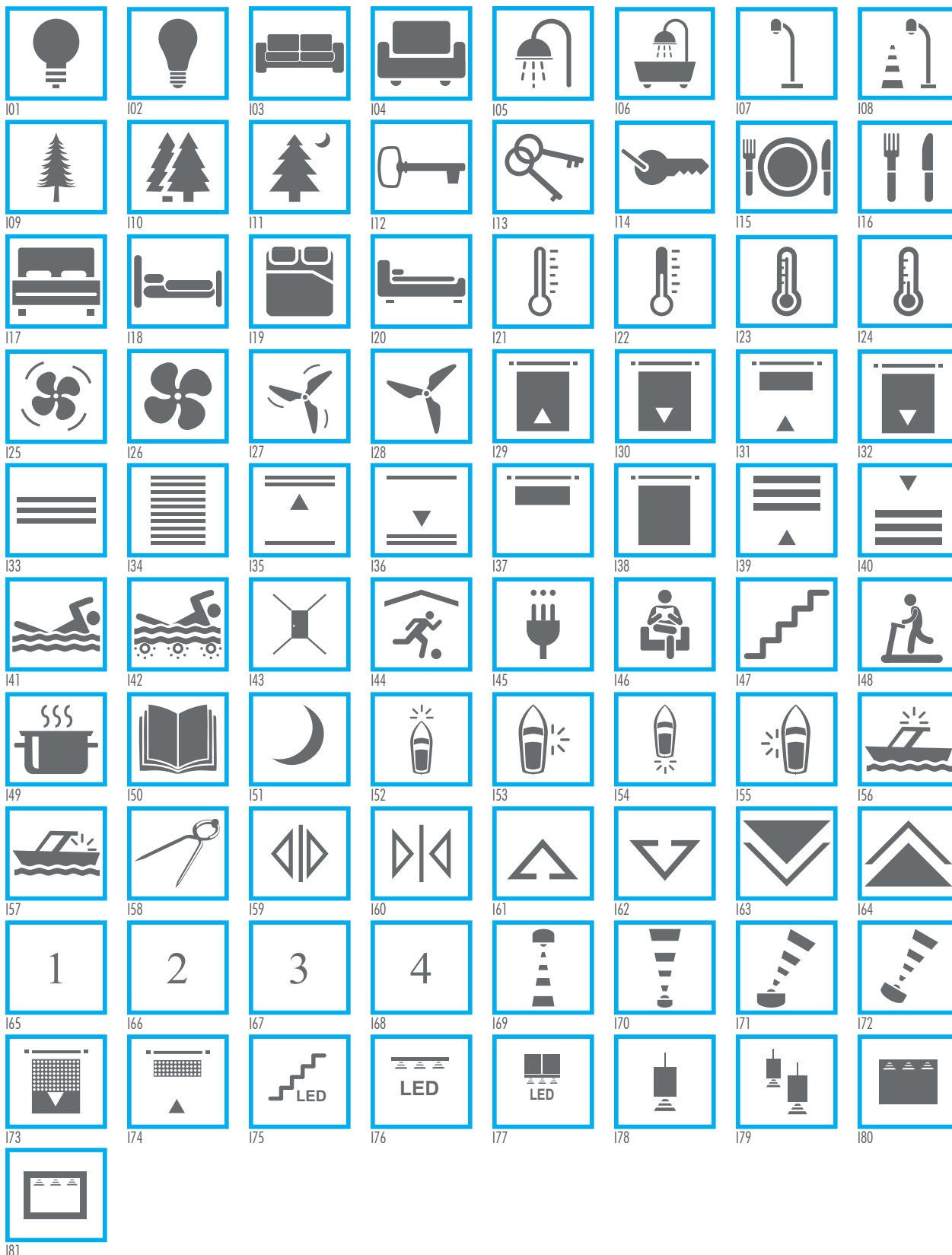





1. Choice of fixing frame: search in the following pages of the short Folder the correct code for this first particular, it is not difficult because they are listed only two measures. The first kit suitable for glass 80x80 mm for fixing of electrical wall box, diameter 60mm. The second kit to fit glass 120x80mm and for fixing on rectangular box for 3 fruits (GANG)
2. Choice of enclosure body: for all sizes (80x120 or 80x80) there are two versions: the first one is a single enclosure of 30mm height to be glued on the support (5) with the supplied adhesive tape, the second one is the first of two parts to be glued on support on which to assemble the second part KNX or for specialized terminals, called Back Closure to choose to step 3.
3. Choice of the rear closure: the back must closure must be selected in accordance with the size of the enclosure body (80x80 or 80x120) and with the application for which will be developed the product, KNX or with terminals.
4. Choice of double-sided adhesive: choose the double-sided adhesive required for bonding the container on the support and the glass on the support, in accordance with the two measures 80x80 and 80x120. In order to anchor the glass on the support and to cover the voltage sockets use the double-sided adhesive for glass. Buy also the double-sided circular if you intend to produce a device with electronic SLIDER circular adhesivize directly on the glass.
5. Choice of support: select the support in accordance with the size (80x120 or 80x80) and with the number of keys you wish to obtain or to cover the voltage sockets.
6. Send files of the graphic you want on the glass for our offer. On the Short Folder folder are shown some examples with prices.
7. Selection of Glass: choose the glass in accordance with the measures of the support (80x80 or 80x120), also choose the glass completely flat to create your electronics with keys, with central opening for the voltage sockets or, finally, with downward circular sliders. The glasses are supplied in transparent version without any graphic customization. The graphics can be customized according to your specific request or you can order glasses with our graphic standards as listed in the short folder, which includes prices and quantities.
8. Choice of the cross\_light separator: choose the separator in accordance with the size of the glass (80x80 or 80x120). To be adjusted prior to be assembled by cutting the excess parts, in accordance with the number of keys.

ICONS SPECIAL FINISHING GLASS iGlass







## INDICE / INDEX

## PARTI CONTENITORE/ SPARE PARTS ENCLOSURE

	P14001305C	Cornice per scatola elettrica tipo 503/ Frame for electrical enclosure 503 type (3 Gangs)	PAG 17
	P14002305C	Cornice per scatola elettrica tipo D60/ Frame for electrical enclosure D60 type	PAG 17
	P14102305S	Corpo contenitore per D60/H20 Body enclosure for D60/H20	PAG 17
	P14101305S	Corpo contenitore per 503/H20 Body enclosure for 503(3 Gangs)/H20	PAG 18
	P14001305S	Corpo contenitore per 503/H30 / Body enclosure for 503(3 Gangs)/H30	PAG 18
	P14002305S	Corpo contenitore per D60/H30 / Body enclosure for D60/H30	PAG 18
	P14201305S	Chiusura posteriore con agganci 503/H20 Back cover with hooks for enclosure 503 (3 Gangs) use/H20	PAG 19
	P14202305S	Chiusura posteriore con agganci D60/H20 Back cover with hooks for enclosure D60 use/H20	PAG 19
	P14204305S	Chiusura posteriore con agganci D60 KNX Back cover with hooks for enclosure D60 KNX	PAG 19
	P14203305S	Chiusura posteriore con agganci 503 KNX Back cover with hooks for enclosure 503 (3 Gangs) KNX	PAG 20





## SUPPORTO/SUPPORT

	P14006721P	Supporto per vetro 80.80 4 tasti iGlass per cross light Support for glass 80.80 4 switches iGlass for cross light	PAG 20
	P14005721P	Supporto per vetro 80.80 2 tasti iGlass per cross light Support for glass 80.80 2 switches iGlass for cross light	PAG 20
	P14004721P	Supporto per vetro 80.80 1 tasto iGlass Support for glass 80.80 1 switch iGlass	PAG 21
	14.211110B	Supporto per vetro 80.80 slider iGlass Support for glass 80.80 slider iGlass	PAG 21

## SUPPORTO/SUPPORT





	14.200010C	Supporto copriplacca D60/Axolute Support plugcover D60/Axolute	PAG 21
	P14007721P	Supporto per vetro 80.120 6 tasti iGlass per cross light Support for glass 80.120 6 switches iGlass for cross light	PAG 22
	P14008721P	Supporto per vetro 80.120 3 tasti iGlass per cross light Support for glass 80.120 3 switches iGlass for cross light	PAG 22
	P14002721P	Supporto per vetro 80.120 1 tasto iGlass Support for glass 80.120 1 switch iGlass	PAG 22
	14.212110D	Supporto per vetro 80.120 slider iGlass Support for glass 80.120 slider iGlass	PAG 23
	P14003721C	Supporto copriplacca 503/Axolute Support plugcover 503 (3 Gangs)/Axolute	PAG 23

## BIADESIVO/DOUBLE SIDED ADHESIVE

	14.1BT2OSP	Biadesivo per vetro 80.120 tasti e slider, standard Double sided adhesive for glass 80.120 switches and slider, standard	PAG 23
	14.1BT1OSP	Biadesivo per vetro 80.80 tasti e slider, standard Double sided adhesive for glass 80.80 switches and slider, standard	PAG 24
	P14004503A	Biadesivo per contenitore 503 Double sided adhesive for enclosure 503 (3 Gangs)	PAG 24
	P14000260A	Biadesivo per contenitore D60/ Double sided adhesive for enclosure D60	PAG 24
	P14000560A	Biadesivo per scheda slider D60/503 Double sided adhesive for PCB slider D60/503 (3 Gangs)	PAG 25

INDICE / INDEX

VETRO/GLASS



	14.10811SP	Vetro 80.80 trasparente per tasti e slider Glass 80.80 transparent for switches and slider	PAG 25
	14.11211SP	Vetro 80.120 trasparente per tasti e slider Glass 80.120 transparent for switches and slider	PAG 25
	P14033812V	Vetro Copriplacca Axolute 80.80 Glass coverplate Axolute 80.80	PAG 26
	P14033509V	Vetro Copriplacca Axolute 80.120 Glass coverplate Axolute 80.120	PAG 26

STAMPA GRAFICA DIGITALE  
DIGITAL GRAPHIC PRINT

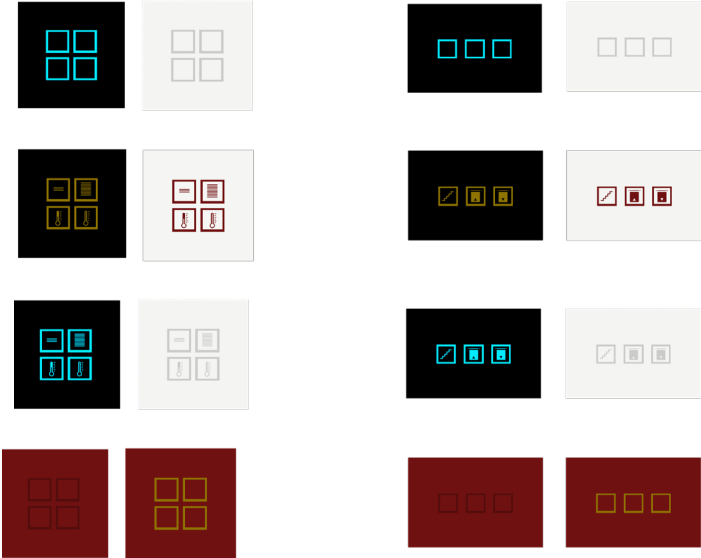

STAMPA DIGITALE PER QUANTITÀ MOLTO BASSE DISPONIBILE A COSTI MOLTO CONVENIENTI.  
DIGITAL PRINT AVAILABLE FOR VERY LOW QUANTITY, LOW COST.





SEPARATORE  
SEPARATOR

	P1400002E	Separatore in gomma per riduzione cross light 2T/4T 80.80 Rubber separator for cross light reduction 2T/4T 80.80	PAG 26
	P1400003E	Separatore in gomma per riduzione cross light 3T/6T 80.120 Rubber separator for cross light reduction 3T/6T 80.120	PAG 27

ETICHETTA ADESIVA  
ADHESIVE LABEL

	P1400005E	Etichetta adesiva per 80.80 Adhesive label for 80.80	PAG 27
	P1400006E	Etichetta adesiva per 80.120 Adhesive label for 80.120	PAG 27

MASCHERA ASSEMB.  
MASK

	14.MAS2000	Maschera per assemblaggio vetro su Supporto in plastica 80.80 Tools for glass assembly over Plastic support 80.80	PAG 28
	14.MAS1000	Maschera per assemblaggio vetro su Supporto in plastica 80.120 Tools for glass assembly over Plastic support 80.120	PAG 28

## KIT CONTENITORE/KIT ENCLOSURE

	14.400011	Kit contenitore, D60, 80.80, Tasti/Slider, H20 bianco Kit Enclosure D60 80.80 Switches/Slider H20 White	PAG 28
	14.400010	Kit contenitore, D60, 80.80, Tasti/Slider, H30 bianco Kit Enclosure D60 80.80 Switches/Slider H30 White	PAG 29
	14.400012	Kit contenitore, D60, 80.80, Tasti/Slider, KNX H20 bianco Kit Enclosure D60 80.80 Switches/Slider KNX H20 white	PAG 29
	14.400021	Kit contenitore, 503, 80.120, Tasti/Slider, H20 bianco Kit Enclosure 503 80.120 Switches/Slider H20 white	PAG 29
	14.400020	Kit contenitore, 503, 80.120, Tasti/Slider, H30 bianco Kit Enclosure 503 80.120 Switches/Slider H30 white	PAG 30
	14.400024	Kit contenitore, 503, 80.120, Tasti/Slider KNX H20 bianco Kit Enclosure 503 80.120 Switches/Slider KNX H20 white	PAG 30



## INDICE / INDEX

VETRO CON GRAFICA SENZA BIADESIVO/GLASS WITH GRAPHIC WITHOUT DOUBLE SIDED ADHESIVE



14.G222100 Vetro 80.80 con grafica tasti n.1 nero standard  
80.80 glass with graphic 1 switch standard black

PAG 30



14.G211100 Vetro 80.80 con grafica tasti n.1 bianco standard  
80.80 glass with graphic 1 switch standard white

PAG 31



14.G222200 Vetro 80.80 con grafica tasti n.2 nero standard  
80.80 glass with graphic 2 switches standard black

PAG 31



14.G211200 Vetro 80.80 con grafica tasti n.2 bianco standard  
80.80 glass with graphic 2 switches standard white

PAG 31



14.G222400 Vetro 80.80 con grafica tasti n.4 nero standard  
80.80 glass with graphic 4 switches standard black

PAG 32



14.G211400 Vetro 80.80 con grafica tasti n.4 bianco standard  
80.80 glass with graphic 4 switches standard white

PAG 32



14.G122100 Vetro 80.120 con grafica tasti n.1 nero standard  
80.120 glass with graphic 1 switch standard black

PAG 32



14.G111100 Vetro 80.120 con grafica tasti n.1 bianco standard  
80.120 glass with graphic 1 switch standard white

PAG 33



14.G122300 Vetro 80.120 con grafica tasti n.3 nero standard  
80.120 glass with graphic 3 switches standard black

PAG 33



14.G111300 Vetro 80.120 con grafica tasti n.3 bianco standard  
80.120 glass with graphic 3 switches standard white

PAG 33



14.G122600 Vetro 80.120 con grafica tasti n.6 nero standard  
80.120 glass with graphic 6 switches standard black

PAG 34



14.G111600 Vetro 80.120 con grafica tasti n.6 bianco standard  
80.120 glass with graphic 6 switches standard white

PAG 34

## iGlass

## SCATOLE/BOXES

	P14D00260P	Imballo per dispositivo iGlass 80x80 bianco 110x110x70mm Packaging for DEVICE iGlass 80x80 white 110x110x70mm	PAG 34
	P14C00260P	Imballo per copriplacca iGlass 80x80 bianco 110x110x30mm Packaging for Cover Frame iGlass 80x80 white 110x110x30mm	PAG 35
	P14D04503P	Imballo per dispositivo iGlass 80x120 bianco 110x150x70mm Packaging for DEVICE iGlass 80x120 white 110x150x70mm	PAG 35
	P14C04503P	Imballo per copriplacca iGlass 80x120 bianco 110x150x30mm Packaging for Cover Frame iGlass 80x120 white 110x150x30mm	PAG 35

## ASSEMBLAGGIO/ASSEMBLY

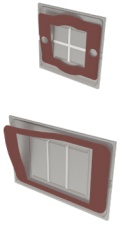
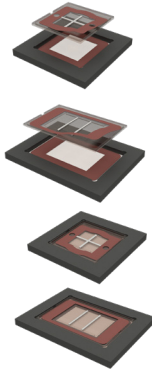
	14.1AV30SP	Assemblaggio biadesivo su vetro Double sided adhesive assembly on glass	PAG 36
	14.1AV40SP	Assemblaggio biadesivo su supporto Double sided adhesive assembly on support	PAG 36
	14.1AV10SP	Assemblaggio vetro con biadesivo su supporto Glass assembly with Double sided adhesive on support	PAG 36

## FINISHING SERVICE

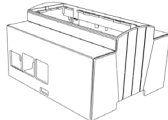
	Finishing service	PAG 39
---	-------------------	--------

**CORNICE****CARATTERISTICHE GENERALI****Materiale:** ABS autoestinguente**Colore:** Bianco

Cornice per fissaggio su scatola elettrica tipo D60 mm oppure 70x70 UK

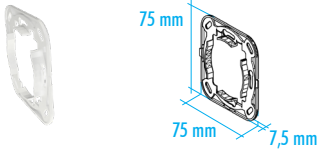
**FRAME****GENERAL FEATURES****Material:** ABS self-extinguishing**Colour:** White

Frame for electrical enclosure D60 type or 70x70 UK, use



CODICE / CODE	COLORE / COLOUR	DESCRIZIONE/DESCRIPTION
P14002305C	Bianco/White	Cornice per scatola elettrica tipo D60/ Frame for electrical enclosure D60 type

<b>CONFEZIONE N° PCS/KIT:</b>	<b>100</b>
<b>PACKAGING N° PCS/KIT:</b>	<b>100</b>
<b>PESO DELLA CONFEZIONE:</b>	<b>0,91 kg</b>
<b>PACKAGING WEIGHT:</b>	<b>0,91 kg</b>

<b>MINIMO ACQUISTABILE:</b>	<b>1</b>
<b>MINIMUM ORDER:</b>	<b>1</b>
<b>PESO DEL PEZZO KIT:</b>	<b>7 g</b>
<b>KIT WEIGHT:</b>	<b>7 g</b>

**CORNICE****CARATTERISTICHE GENERALI****Materiale:** ABS autoestinguente**Colore:** Bianco

Cornice per fissaggio su scatola elettrica tipo 503 mm

**FRAME****GENERAL FEATURES****Material:** ABS self-extinguishing**Colour:** White

Frame for electrical enclosure 503 type, use



CODICE / CODE	COLORE / COLOUR	DESCRIZIONE/DESCRIPTION
P14001305C	Bianco/White	Cornice per scatola elettrica tipo 503/ Frame for electrical enclosure 503 type (3 Gangs)

<b>CONFEZIONE N° PCS/KIT:</b>	<b>100</b>
<b>PACKAGING N° PCS/KIT:</b>	<b>100</b>
<b>PESO DELLA CONFEZIONE:</b>	<b>0,95 kg</b>
<b>PACKAGING WEIGHT:</b>	<b>0,95 kg</b>

<b>MINIMO ACQUISTABILE:</b>	<b>1</b>
<b>MINIMUM ORDER:</b>	<b>1</b>
<b>PESO DEL PEZZO KIT:</b>	<b>8 g</b>
<b>KIT WEIGHT:</b>	<b>8 g</b>

**CORPO CONTENITORE****CARATTERISTICHE GENERALI****Materiale:** ABS autoestinguente**Colore:** Bianco

Corpo contenitore per scatola elettrica tipo D60 mm o 70x70 UK

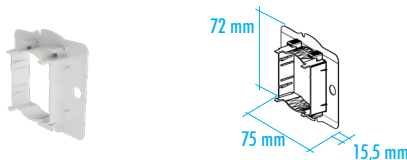
**BODY ENCLOSURE****GENERAL FEATURES****Material:** ABS self-extinguishing**Colour:** White

Body enclosure for electrical enclosure D60 type or 70x70 UK, use

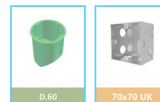

CODICE / CODE	COLORE / COLOUR	DESCRIZIONE/DESCRIPTION
P14102305S	Bianco/White	Corpo contenitore per D60/H20/KNX/ Body enclosure for D60/H20/KNX

<b>CONFEZIONE N° PCS/KIT:</b>	<b>100</b>
<b>PACKAGING N° PCS/KIT:</b>	<b>100</b>
<b>PESO DELLA CONFEZIONE:</b>	<b>0,78 kg</b>
<b>PACKAGING WEIGHT:</b>	<b>0,78 kg</b>

<b>MINIMO ACQUISTABILE:</b>	<b>1</b>
<b>MINIMUM ORDER:</b>	<b>1</b>
<b>PESO DEL PEZZO KIT:</b>	<b>6 g</b>
<b>KIT WEIGHT:</b>	<b>6 g</b>

## CORPO CONTENITORE CARATTERISTICHE GENERALI

**Materiale:** ABS autoestinguente

**Colore:** Bianco

Corpo contenitore per scatola elettrica tipo D60 mm o 70x70 UK o 503

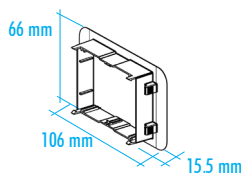

## BODY ENCLOSURE GENERAL FEATURES

**Material:** ABS self-extinguishing

**Colour:** White

Body enclosure for electrical enclosure 503 type, use



CODICE / CODE	COLORE / COLOUR	DESCRIZIONE/DESCRIPTION
P14101305S	Bianca/White	Corpo contenitore per 503/H20/KNX / Body enclosure for 503(3 Gangs)/H20/KNX

<b>CONFEZIONE N° PCS/KIT:</b>	<b>100</b>
<b>PACKAGING N° PCS/KIT:</b>	<b>100</b>
<b>PESO DELLA CONFEZIONE:</b>	<b>0,96 kg</b>
<b>PACKAGING WEIGHT:</b>	<b>0,96 kg</b>

<b>MINIMO ACQUISTABILE:</b>	<b>1</b>
<b>MINIMUM ORDER:</b>	<b>1</b>
<b>PESO DEL PEZZO KIT:</b>	<b>8 g</b>
<b>KIT WEIGHT:</b>	<b>8 g</b>

## CORPO CONTENITORE CARATTERISTICHE GENERALI

**Materiale:** ABS autoestinguente

**Colore:** Bianco

Corpo contenitore per scatola elettrica tipo D60 mm o 70x70 UK

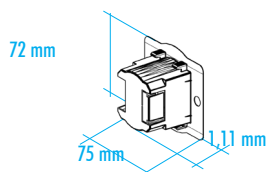

## BODY ENCLOSURE GENERAL FEATURES

**Material:** ABS self-extinguishing

**Colour:** White

Body enclosure for electrical enclosure D60 type or 70x70 UK, use

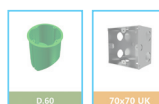

CODICE / CODE	COLORE / COLOUR	DESCRIZIONE/DESCRIPTION
P14002305S	Bianca/White	Corpo contenitore per D60/H30 / Body enclosure for D60/H30

<b>CONFEZIONE N° PCS/KIT:</b>	<b>100</b>
<b>PACKAGING N° PCS/KIT:</b>	<b>100</b>
<b>PESO DELLA CONFEZIONE:</b>	<b>1,3 kg</b>
<b>PACKAGING WEIGHT:</b>	<b>1,3 kg</b>

<b>MINIMO ACQUISTABILE:</b>	<b>1</b>
<b>MINIMUM ORDER:</b>	<b>1</b>
<b>PESO DEL PEZZO KIT:</b>	<b>11 g</b>
<b>KIT WEIGHT:</b>	<b>11 g</b>

## CORPO CONTENITORE CARATTERISTICHE GENERALI

**Materiale:** ABS autoestinguente

**Colore:** Bianco

Corpo contenitore per scatola elettrica tipo D60 mm o 70x70 UK o 503

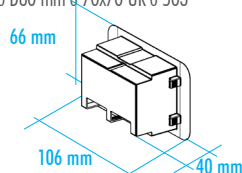

## BODY ENCLOSURE GENERAL FEATURES

**Material:** ABS self-extinguishing

**Colour:** White

Body enclosure for electrical enclosure 503 type, use



CODICE / CODE	COLORE / COLOUR	DESCRIZIONE/DESCRIPTION
P14001305S	Bianca/White	Corpo contenitore per 503/H30 / Body enclosure for 503(3 Gangs)/H30

<b>CONFEZIONE N° PCS/KIT:</b>	<b>100</b>
<b>PACKAGING N° PCS/KIT:</b>	<b>100</b>
<b>PESO DELLA CONFEZIONE:</b>	<b>2 kg</b>
<b>PACKAGING WEIGHT:</b>	<b>2 kg</b>

<b>MINIMO ACQUISTABILE:</b>	<b>1</b>
<b>MINIMUM ORDER:</b>	<b>1</b>
<b>PESO DEL PEZZO KIT:</b>	<b>18 g</b>
<b>KIT WEIGHT:</b>	<b>18 g</b>

**CHIUSURA****CARATTERISTICHE GENERALI****Materiale:** ABS autoestinguente**Colore:** Bianco

Chiusura posteriore per contenitore per scatola elettrica tipo D60 mm H20

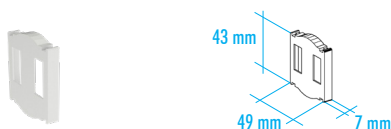
**BACK COVER****GENERAL FEATURES****Material:** ABS self-extinguishing**Colour:** White

Rear cover for electrical enclosure D60 type or 70x70 UK, use

**CODICE / CODE COLORE / COLOUR DESCRIZIONE/DESCRIPTION**

CODICE / CODE	COLORE / COLOUR	DESCRIZIONE/DESCRIPTION
P14202305S	Bianco/White	Chiusura posteriore con agganci D60/H20 / Back cover with hooks for enclosure D60 use/H20

<b>CONFEZIONE N° PCS/KIT:</b>	<b>100</b>
<b>PACKAGING N° PCS/KIT:</b>	<b>100</b>

<b>MINIMO ACQUISTABILE:</b>	<b>1</b>
<b>MINIMUM ORDER:</b>	<b>1</b>

<b>PESO DELLA CONFEZIONE:</b>	<b>0,5 kg</b>
<b>PACKAGING WEIGHT:</b>	<b>0,5 kg</b>

<b>PESO DEL PEZZO KIT:</b>	<b>3 g</b>
<b>KIT WEIGHT:</b>	<b>3 g</b>

**CHIUSURA****CARATTERISTICHE GENERALI****Materiale:** ABS autoestinguente**Colore:** Bianco

Chiusura posteriore per contenitore per scatola elettrica tipo 503

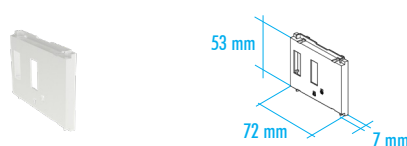
**BACK COVER****GENERAL FEATURES****Material:** ABS self-extinguishing**Colour:** White

Rear cover for electrical enclosure 503 type, use

**CODICE / CODE COLORE / COLOUR DESCRIZIONE/DESCRIPTION**

CODICE / CODE	COLORE / COLOUR	DESCRIZIONE/DESCRIPTION
P14201305S	Bianco/White	Chiusura posteriore con agganci 503/H20 / Back cover with hooks for enclosure 503 (3 Gangs) use/H20

<b>CONFEZIONE N° PCS/KIT:</b>	<b>100</b>
<b>PACKAGING N° PCS/KIT:</b>	<b>100</b>

<b>MINIMO ACQUISTABILE:</b>	<b>1</b>
<b>MINIMUM ORDER:</b>	<b>1</b>

<b>PESO DELLA CONFEZIONE:</b>	<b>0,98 kg</b>
<b>PACKAGING WEIGHT:</b>	<b>0,98 kg</b>

<b>PESO DEL PEZZO KIT:</b>	<b>8 g</b>
<b>KIT WEIGHT:</b>	<b>8 g</b>

**CHIUSURA****CARATTERISTICHE GENERALI****Materiale:** Plastica autoestinguente**Colore:** Bianco

Chiusura posteriore per contenitore per scatola elettrica tipo D60 mm o 70x70 UK

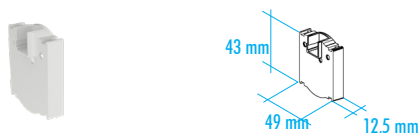
**BACK COVER****GENERAL FEATURES****Material:** Plastic self-extinguishing**Colour:** White

Rear cover for electrical enclosure 503 type, use

**CODICE / CODE COLORE / COLOUR DESCRIZIONE/DESCRIPTION**

CODICE / CODE	COLORE / COLOUR	DESCRIZIONE/DESCRIPTION
P14204305S	Bianco/White	Chiusura posteriore con agganci D60 KNX / Back cover with hooks for enclosure D60 KNX

<b>CONFEZIONE N° PCS/KIT:</b>	<b>100</b>
<b>PACKAGING N° PCS/KIT:</b>	<b>100</b>

<b>MINIMO ACQUISTABILE:</b>	<b>1</b>
<b>MINIMUM ORDER:</b>	<b>1</b>

<b>PESO DELLA CONFEZIONE:</b>	<b>0,98 kg</b>
<b>PACKAGING WEIGHT:</b>	<b>0,98 kg</b>

<b>PESO DEL PEZZO KIT:</b>	<b>8 g</b>
<b>KIT WEIGHT:</b>	<b>8 g</b>

**CHIUSURA****CARATTERISTICHE GENERALI****Materiale:** ABS autoestinguente**Colore:** Bianco

Chiusura posteriore per contenitore per scatola elettrica tipo D60 mm o 70x70 UK o 503

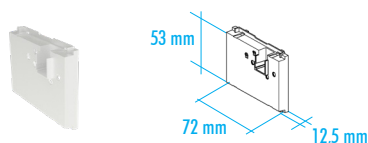
**BACK COVER****GENERAL FEATURES****Material:** ABS self-extinguishing**Colour:** White

Rear cover for electrical enclosure D60 type or 70x70 UK, use



CODICE / CODE	COLORE / COLOUR	DESCRIZIONE/DESCRIPTION
P14203305S	Bianco/White	Chiusura posteriore con agganci 503 KNX/ Back cover with hooks for enclosure 503 (3 Gangs) KNX

CONFEZIONE N° PCS/KIT:	100
PACKAGING N° PCS/KIT:	100

MINIMO ACQUISTABILE:	1
MINIMUM ORDER:	1

PESO DELLA CONFEZIONE:	0,5 kg
PACKAGING WEIGHT:	0,5 kg

PESO DEL PEZZO KIT:	3 g
KIT WEIGHT:	3 g

**SUPPORTO****CARATTERISTICHE GENERALI****Materiale:** PC autoestinguente**Colore:** Trasparente

Supporto per vetro 80.80 versione 4 tasti con ribasso per ospitare il separatore anti cross-light.

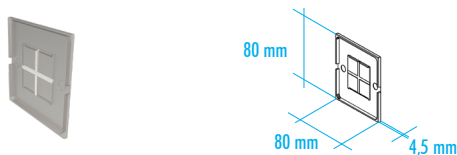
**SUPPORT****GENERAL FEATURES****Material:** PC self-extinguishing**Colour:** Transparent

Support for Glass 80.80, 4 switches version, with milling for anti cross-light separator.



CODICE / CODE	COLORE / COLOUR	DESCRIZIONE/DESCRIPTION
P14006721P	Trasparente/Transparent	Supporto per vetro 80.80 4 tasti iGlass per cross light / Support for glass 80.80 4 switches iGlass for cross light

CONFEZIONE N° PCS/KIT:	100
PACKAGING N° PCS/KIT:	100

MINIMO ACQUISTABILE:	1
MINIMUM ORDER:	1

PESO DELLA CONFEZIONE:	1,6 kg
PACKAGING WEIGHT:	1,6 kg

PESO DEL PEZZO KIT:	14 g
KIT WEIGHT:	14 g

**SUPPORTO****CARATTERISTICHE GENERALI****Materiale:** PC autoestinguente**Colore:** Trasparente

Supporto per vetro 80.80 versione 2 tasti con ribasso per ospitare il separatore anti cross-light.

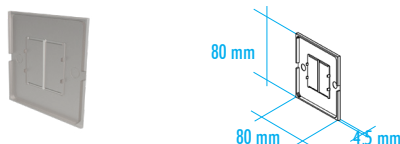
**SUPPORT****GENERAL FEATURES****Material:** PC self-extinguishing**Colour:** Transparent

Support for Glass 80.80, 2 switches version, with milling for anti cross-light separator.



CODICE / CODE	COLORE / COLOUR	DESCRIZIONE/DESCRIPTION
P14005721P	Trasparente/Transparent	Supporto per vetro 80.80 2 tasti iGlass per cross light / Support for glass 80.80 2 switches iGlass for cross light

CONFEZIONE N° PCS/KIT:	100
PACKAGING N° PCS/KIT:	100

MINIMO ACQUISTABILE:	1
MINIMUM ORDER:	1

PESO DELLA CONFEZIONE:	1,6 kg
PACKAGING WEIGHT:	1,6 kg

PESO DEL PEZZO KIT:	14 g
KIT WEIGHT:	14 g

**SUPPORTO****CARATTERISTICHE GENERALI****Materiale:** PC autoestinguente**Colore:** Trasparente

Supporto per vetro 80.80 versione 1 tasto con ribasso per ospitare il separatore anti cross-light.

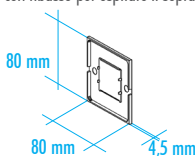
**SUPPORT****GENERAL FEATURES****Material:** PC self-extinguishing**Colour:** Transparent

Support for Glass 80.80, 1 switches version, with milling for anti cross-light separator.



CODICE / CODE	COLORE / COLOUR	DESCRIZIONE/DESCRIPTION
P14004721P	Trasparente/Transparent	Supporto per vetro 80.80 1 tasto iGlass / Support for glass 80.80 1 switch iGlass

<b>CONFEZIONE N° PCS/KIT:</b>	100
<b>PACKAGING N° PCS/KIT:</b>	100
<b>PESO DELLA CONFEZIONE:</b>	1,6 kg
<b>PACKAGING WEIGHT:</b>	1,6 kg

<b>MINIMO ACQUISTABILE:</b>	1
<b>MINIMUM ORDER:</b>	1
<b>PESO DEL PEZZO KIT:</b>	14 g
<b>KIT WEIGHT:</b>	14 g

**SUPPORTO****CARATTERISTICHE GENERALI****Materiale:** PC autoestinguente**Colore:** Trasparente

Supporto per vetro 80.80 versione slider con ribasso per ospitare il separatore anti cross-light.

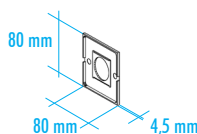
**SUPPORT****GENERAL FEATURES****Material:** PC self-extinguishing**Colour:** Transparent

Support for Glass 80.80, slider version



CODICE / CODE	COLORE / COLOUR	DESCRIZIONE/DESCRIPTION
14.211110B	Trasparente/Transparent	Supporto per vetro 80.80 slider iGlass / Support for glass 80.80 slider iGlass

<b>CONFEZIONE N° PCS/KIT:</b>	100
<b>PACKAGING N° PCS/KIT:</b>	100
<b>PESO DELLA CONFEZIONE:</b>	1,6 kg
<b>PACKAGING WEIGHT:</b>	1,6 kg

<b>MINIMO ACQUISTABILE:</b>	1
<b>MINIMUM ORDER:</b>	1
<b>PESO DEL PEZZO KIT:</b>	14 g
<b>KIT WEIGHT:</b>	14 g

**SUPPORTO****CARATTERISTICHE GENERALI****Materiale:** PC autoestinguente**Colore:** Trasparente

Supporto per vetro 80.80 copriplacca.

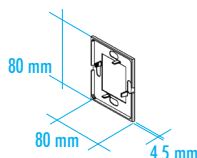
**SUPPORT****GENERAL FEATURES****Material:** PC self-extinguishing**Colour:** Transparent

Support for Glass 80.80 plug cover, AXOLUTE type



CODICE / CODE	COLORE / COLOUR	DESCRIZIONE/DESCRIPTION
14.200010C	Trasparente/Transparent	Supporto copriplacca D60/Axolute / Support plugcover D60/Axolute

<b>CONFEZIONE N° PCS/KIT:</b>	5
<b>PACKAGING N° PCS/KIT:</b>	5
<b>PESO DELLA CONFEZIONE:</b>	0,22 kg
<b>PACKAGING WEIGHT:</b>	0,22 kg

<b>MINIMO ACQUISTABILE:</b>	1
<b>MINIMUM ORDER:</b>	1
<b>PESO DEL PEZZO KIT:</b>	24 g
<b>KIT WEIGHT:</b>	24 g

**SUPPORTO****CARATTERISTICHE GENERALI****Materiale:** PC autoestinguente**Colore:** Trasparente

Supporto per vetro 80.120 versione 6 tasti con ribasso per ospitare il separatore anti cross-light.

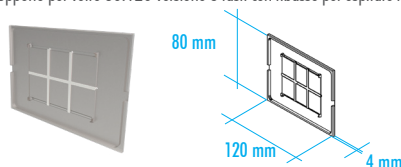
**CODICE / CODE**    **COLORE / COLOUR**    **DESCRIZIONE/DESCRIPTION**

P14007721P    Trasparente/Transparent    Supporto per vetro 80.120 6 tasti iGlass per cross light / Support for glass 80.120 6 switches iGlass for cross light

**SUPPORT****GENERAL FEATURES****Material:** PC self-extinguishing**Colour:** Transparent

Support for Glass 80.120, 6 switches version, with milling for anti cross-light separator

**CONFEZIONE N° PCS/KIT:** 100  
**PACKAGING N° PCS/KIT:** 100**MINIMO ACQUISTABILE:** 1  
**MINIMUM ORDER:** 1**PESO DELLA CONFEZIONE:** 2,1 kg  
**PACKAGING WEIGHT:** 2,1 kg**PESO DEL PEZZO KIT:** 19 g  
**KIT WEIGHT:** 19 g**SUPPORTO****CARATTERISTICHE GENERALI****Materiale:** PC autoestinguente**Colore:** Trasparente

Supporto per vetro 80.120 versione 3 tasti con ribasso per ospitare il separatore anti cross-light.

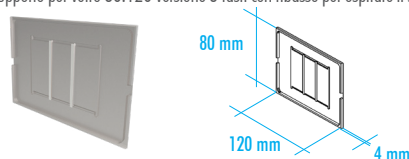
**CODICE / CODE**    **COLORE / COLOUR**    **DESCRIZIONE/DESCRIPTION**

P14008721P    Trasparente/Transparent    Supporto per vetro 80.120 3 tasti iGlass per cross light / Support for glass 80.120 3 switches iGlass for cross light

**SUPPORT****GENERAL FEATURES****Material:** PC self-extinguishing**Colour:** Transparent

Support for Glass 80.120, 3 switches version, with milling for anti cross-light separator.

**CONFEZIONE N° PCS/KIT:** 100  
**PACKAGING N° PCS/KIT:** 100**MINIMO ACQUISTABILE:** 1  
**MINIMUM ORDER:** 1**PESO DELLA CONFEZIONE:** 2,1 kg  
**PACKAGING WEIGHT:** 2,1 kg**PESO DEL PEZZO KIT:** 19 g  
**KIT WEIGHT:** 19 g**SUPPORTO****CARATTERISTICHE GENERALI****Materiale:** PC autoestinguente**Colore:** Trasparente

Supporto per vetro 80.120 versione 1 tasto con ribasso per ospitare il separatore anti cross-light.

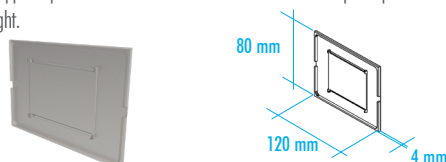
**CODICE / CODE**    **COLORE / COLOUR**    **DESCRIZIONE/DESCRIPTION**

P14002721P    Trasparente/Transparent    Supporto per vetro 80.120 1 tasto iGlass / Support for glass 80.120 1 switch iGlass

**SUPPORT****GENERAL FEATURES****Material:** PC self-extinguishing**Colour:** Transparent

Support for Glass 80.120, 1 switches version, with milling for anti cross-light separator

**CONFEZIONE N° PCS/KIT:** 100  
**PACKAGING N° PCS/KIT:** 100**MINIMO ACQUISTABILE:** 1  
**MINIMUM ORDER:** 1**PESO DELLA CONFEZIONE:** 2,1 kg  
**PACKAGING WEIGHT:** 2,1 kg**PESO DEL PEZZO KIT:** 19 g  
**KIT WEIGHT:** 19 g



**SUPPORTO****CARATTERISTICHE GENERALI****Materiale:** PC autoestinguente**Colore:** Trasparente

Supporto per vetro 80.120 slider con ribasso per ospitare il separatore anti cross-light.

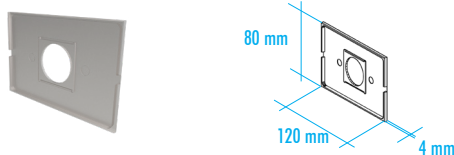
**SUPPORT****GENERAL FEATURES****Material:** PC self-extinguishing**Colour:** Transparent

Support for Glass 80.120, slider version.



CODICE / CODE	COLORE / COLOUR	DESCRIZIONE/DESCRIPTION
14.212110D	Trasparente/Transparent	Supporto per vetro 80.120 slider iGlass / Support for glass 80.120 slider iGlass

<b>CONFEZIONE N° PCS/KIT:</b>	<b>100</b>
<b>PACKAGING N° PCS/KIT:</b>	<b>100</b>
<b>PESO DELLA CONFEZIONE:</b>	<b>2,1 kg</b>
<b>PACKAGING WEIGHT:</b>	<b>2,1 kg</b>

<b>MINIMO ACQUISTABILE:</b>	<b>1</b>
<b>MINIMUM ORDER:</b>	<b>1</b>
<b>PESO DEL PEZZO KIT:</b>	<b>19 g</b>
<b>KIT WEIGHT:</b>	<b>19 g</b>

**SUPPORTO****CARATTERISTICHE GENERALI****Materiale:** PC autoestinguente**Colore:** Trasparente

Supporto per vetro 80.120 axolute

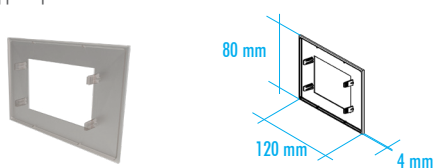
**SUPPORT****GENERAL FEATURES****Material:** PC self-extinguishing**Colour:** Transparent

Support for Glass 80.120 plug cover, AXOLUTE type



CODICE / CODE	COLORE / COLOUR	DESCRIZIONE/DESCRIPTION
P14003721C	Trasparente/Transparent	Supporto caprilacca 503/Axolute / Support plugcover 503 (3 Gangs)/Axolute

<b>CONFEZIONE N° PCS/KIT:</b>	<b>5</b>
<b>PACKAGING N° PCS/KIT:</b>	<b>5</b>
<b>PESO DELLA CONFEZIONE:</b>	<b>0,21 kg</b>
<b>PACKAGING WEIGHT:</b>	<b>0,21 kg</b>

<b>MINIMO ACQUISTABILE:</b>	<b>1</b>
<b>MINIMUM ORDER:</b>	<b>1</b>
<b>PESO DEL PEZZO KIT:</b>	<b>22 g</b>
<b>KIT WEIGHT:</b>	<b>22 g</b>

SUPPORTO/SUPPORT

**BIADESIVO****CARATTERISTICHE GENERALI****Materiale:** Biadesivo

Biadesivo per vetro 80.120

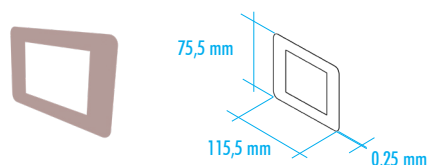
**DOUBLE SIDED ADHESIVE****GENERAL FEATURES****Material:** Biadesive

Biadesive for Glass 80.120



CODICE / CODE	COLORE / COLOUR	DESCRIZIONE/DESCRIPTION
14.1BT2OSP	Trasparente/Transparent	Biadesivo per vetro 80.120 tasti e slider, standard / Double sided adhesive for glass 80.120 switches and slider, standard

<b>CONFEZIONE N° PCS/KIT:</b>	<b>10</b>
<b>PACKAGING N° PCS/KIT:</b>	<b>10</b>
<b>PESO DELLA CONFEZIONE:</b>	<b>0,028 kg</b>
<b>PACKAGING WEIGHT:</b>	<b>0,028 kg</b>

<b>MINIMO ACQUISTABILE:</b>	<b>1</b>
<b>MINIMUM ORDER:</b>	<b>1</b>
<b>PESO DEL PEZZO KIT:</b>	<b>2 g</b>
<b>KIT WEIGHT:</b>	<b>2 g</b>

BIADESIVO/DOUBLE SIDED ADHESIVE

## BIADESIVO CARATTERISTICHE GENERALI

**Materiale:** Biadesivo  
Biadesivo per vetro 80.80

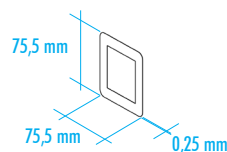

## DOUBLE SIDED ADHESIVE GENERAL FEATURES

**Material:** Biadhesive  
Biadhesive for Glass 80.80



CODICE / CODE	COLORE / COLOUR	DESCRIZIONE/DESCRIPTION
14.1BT10SP	Trasparente/Transparent	Biadesivo per vetro 80.80 tasti e slider, standard / Double sided adhesive for glass 80.80 switches and slider, standard

<b>CONFEZIONE N° PCS/KIT:</b>	<b>10</b>	<b>MINIMO ACQUISTABILE: 1</b>
<b>PACKAGING N° PCS/KIT:</b>	<b>10</b>	<b>MINIMUM ORDER: 1</b>
<b>PESO DELLA CONFEZIONE:</b>	<b>0,019 kg</b>	<b>PESO DEL PEZZO KIT: 1 g</b>
<b>PACKAGING WEIGHT:</b>	<b>0,019 kg</b>	<b>KIT WEIGHT: 1 g</b>

## BIADESIVO CARATTERISTICHE GENERALI

**Materiale:** Biadesivo  
Biadesivo per supporto 80.120

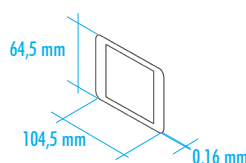

## DOUBLE SIDED ADHESIVE GENERAL FEATURES

**Material:** Biadhesive  
Biadhesive for support 80.120



CODICE / CODE	COLORE / COLOUR	DESCRIZIONE/DESCRIPTION
P14004503A	Trasparente/Transparent	Biadesivo per contenitore 503 / Double sided adhesive for enclosure 503 (3 Gangs)

<b>CONFEZIONE N° PCS/KIT:</b>	<b>10</b>	<b>MINIMO ACQUISTABILE: 1</b>
<b>PACKAGING N° PCS/KIT:</b>	<b>10</b>	<b>MINIMUM ORDER: 1</b>
<b>PESO DELLA CONFEZIONE:</b>	<b>0,015 kg</b>	<b>PESO DEL PEZZO KIT: 1 g</b>
<b>PACKAGING WEIGHT:</b>	<b>0,015 kg</b>	<b>KIT WEIGHT: 1 g</b>

## BIADESIVO CARATTERISTICHE GENERALI

**Materiale:** Biadesivo  
Biadesivo per supporto 80.80

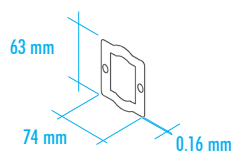

## DOUBLE SIDED ADHESIVE GENERAL FEATURES

**Material:** Biadhesive  
Biadhesive for support 80.80



CODICE / CODE	COLORE / COLOUR	DESCRIZIONE/DESCRIPTION
P14000260A	Trasparente/Transparent	Biadesivo per contenitore D60 / Double sided adhesive for enclosure D60

<b>CONFEZIONE N° PCS/KIT:</b>	<b>10</b>	<b>MINIMO ACQUISTABILE: 1</b>
<b>PACKAGING N° PCS/KIT:</b>	<b>10</b>	<b>MINIMUM ORDER: 1</b>
<b>PESO DELLA CONFEZIONE:</b>	<b>0,015 kg</b>	<b>PESO DEL PEZZO KIT: 1 g</b>
<b>PACKAGING WEIGHT:</b>	<b>0,015 kg</b>	<b>KIT WEIGHT: 1 g</b>

## BIADESIVO

### CARATTERISTICHE GENERALI

**Materiale:** Biadesivo

Biadesivo per slider

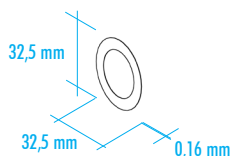

## DOUBLE SIDED ADHESIVE

### GENERAL FEATURES

**Material:** Biadhesive

Biadhesive for slider



CODICE / CODE	COLORE / COLOUR	DESCRIZIONE/DESCRIPTION
P14000560A	Trasparente/Transparent	Biadesivo per scheda slider D60/503 / Double sided adhesive for PCB slider D60/503 (3 Gangs)

<b>CONFEZIONE N° PCS/KIT:</b>	<b>10</b>	<b>MINIMO ACQUISTABILE: 1</b>
<b>PACKAGING N° PCS/KIT:</b>	<b>10</b>	<b>MINIMUM ORDER: 1</b>
<b>PESO DELLA CONFEZIONE:</b>	<b>0,055 kg</b>	<b>PESO DEL PEZZO KIT: 5 g</b>
<b>PACKAGING WEIGHT:</b>	<b>0,055 kg</b>	<b>KIT WEIGHT: 5 g</b>

## VETRO

### CARATTERISTICHE GENERALI

**Materiale:** Vetro temperato

**Colore:** Trasparente

Vetro 80.80

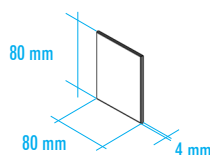

## GLASS

### GENERAL FEATURES

**Material:** Tempered glass

**Colour:** Transparent

Glass 80.80



CODICE / CODE	COLORE / COLOUR	DESCRIZIONE/DESCRIPTION
14.10811SP	Trasparente/Transparent	Vetro 80.80 trasparente per tasti e slider / Glass 80.80 transparent for switches and slider

<b>CONFEZIONE N° PCS/KIT:</b>	<b>5</b>	<b>MINIMO ACQUISTABILE: 1</b>
<b>PACKAGING N° PCS/KIT:</b>	<b>5</b>	<b>MINIMUM ORDER: 1</b>
<b>PESO DELLA CONFEZIONE:</b>	<b>0,405 kg</b>	<b>PESO DEL PEZZO KIT: 61 g</b>
<b>PACKAGING WEIGHT:</b>	<b>0,405 kg</b>	<b>KIT WEIGHT: 61 g</b>

## VETRO

### CARATTERISTICHE GENERALI

**Materiale:** Vetro temperato

**Colore:** Trasparente

Vetro 80.120

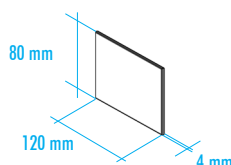

## GLASS

### GENERAL FEATURES

**Material:** Tempered glass

**Colour:** Transparent

Glass 80.120



CODICE / CODE	COLORE / COLOUR	DESCRIZIONE/DESCRIPTION
14.11211SP	Trasparente/Transparent	Vetro 80.120 trasparente per tasti e slider / Glass 80.120 transparent for switches and slider

<b>CONFEZIONE N° PCS/KIT:</b>	<b>5</b>	<b>MINIMO ACQUISTABILE: 1</b>
<b>PACKAGING N° PCS/KIT:</b>	<b>5</b>	<b>MINIMUM ORDER: 1</b>
<b>PESO DELLA CONFEZIONE:</b>	<b>0,565 kg</b>	<b>PESO DEL PEZZO KIT: 93 g</b>
<b>PACKAGING WEIGHT:</b>	<b>0,565 kg</b>	<b>KIT WEIGHT: 93 g</b>

## VETRO

## CARATTERISTICHE GENERALI

**Materiale:** Vetro temperato

**Colore:** Trasparente

Vetro 80.80 copriplacca

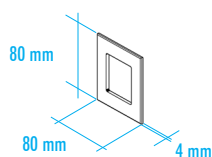

## GLASS

## GENERAL FEATURES

**Material:** Tempered glass

**Colour:** Transparent

Glass 80.80 plug cover



CODICE / CODE	COLORE / COLOUR	DESCRIZIONE/DESCRIPTION
P14033812V	Trasparente/Transparent	Vetro Copriplacca Axolute 80.80 / Glass coverplate Axolute 80.80

**CONFEZIONE N° PCS/KIT:** 5  
**PACKAGING N° PCS/KIT:** 5

**PESO DELLA CONFEZIONE:** 0,3 kg  
**PACKAGING WEIGHT:** 0,3 kg

**MINIMO ACQUISTABILE:** 1  
**MINIMUM ORDER:** 1

**PESO DEL PEZZO KIT:** 40 g  
**KIT WEIGHT:** 40 g

## VETRO

## CARATTERISTICHE GENERALI

**Materiale:** Vetro temperato

**Colore:** Trasparente

Vetro 80.120 copriplacca

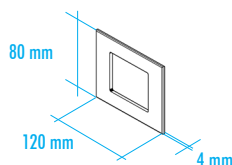

## GLASS

## GENERAL FEATURES

**Material:** Tempered glass

**Colour:** Transparent

Glass 80.120 plug cover



CODICE / CODE	COLORE / COLOUR	DESCRIZIONE/DESCRIPTION
P14033509V	Trasparente/Transparent	Vetro Copriplacca Axolute 80.120 / Glass coverplate Axolute 80.120

**CONFEZIONE N° PCS/KIT:** 5  
**PACKAGING N° PCS/KIT:** 5

**PESO DELLA CONFEZIONE:** 0,395 kg  
**PACKAGING WEIGHT:** 0,395 kg

**MINIMO ACQUISTABILE:** 1  
**MINIMUM ORDER:** 1

**PESO DEL PEZZO KIT:** 59 g  
**KIT WEIGHT:** 59 g

VETRO/GLASS

## SEPARATORE

## CARATTERISTICHE GENERALI

**Materiale:** Gomma

**Colore:** Bianco

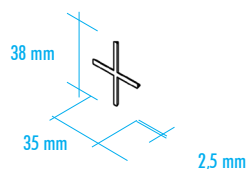

## SEPARATOR

## GENERAL FEATURES

**Material:** Rubber

**Colour:** White



CODICE / CODE	COLORE / COLOUR	DESCRIZIONE/DESCRIPTION
P14000002E	Trasparente/Transparent	Separatore in gomma per riduzione cross light 2T/4T 80.80 / Rubber separator for cross light reduction 2T/4T 80.80

**CONFEZIONE N° PCS/KIT:** 100  
**PACKAGING N° PCS/KIT:** 100

**PESO DELLA CONFEZIONE:** 0,007 kg  
**PACKAGING WEIGHT:** 0,007 kg

**MINIMO ACQUISTABILE:** 1  
**MINIMUM ORDER:** 1

**PESO DEL PEZZO KIT:** 0,02 g  
**KIT WEIGHT:** 0,02 g

SEPARATORE/SEPARATOR

**SEPARATORE**

**CARATTERISTICHE GENERALI**

**Materiale:** Gomma  
**Colore:** Bianco

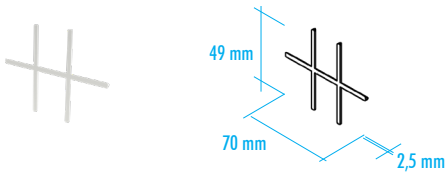

**SEPARATOR**

**GENERAL FEATURES**

**Material:** Rubber  
**Colour:** White



CODICE / CODE	COLORE / COLOUR	DESCRIZIONE/DESCRIPTION
P1400003E	Trasparente/Transparent	Separatore in gomma per riduzione cross light 3T/6T 80.120 / Rubber separator for cross light reduction 3T/6T 80.120

<b>CONFEZIONE N° PCS/KIT:</b>	<b>100</b>
<b>PACKAGING N° PCS/KIT:</b>	<b>100</b>
<b>PESO DELLA CONFEZIONE:</b>	<b>0,009 kg</b>
<b>PACKAGING WEIGHT:</b>	<b>0,009 kg</b>

<b>MINIMO ACQUISTABILE:</b>	<b>1</b>
<b>MINIMUM ORDER:</b>	<b>1</b>
<b>PESO DEL PEZZO KIT:</b>	<b>0,04 g</b>
<b>KIT WEIGHT:</b>	<b>0,04 g</b>

**ETICHETTA ADESIVA 80.80**

**CARATTERISTICHE GENERALI**

Per migliorare la diffusione luminosa è opportuno utilizzare l'adesivo da incollare nel circuito stampato fornito come accessorio.

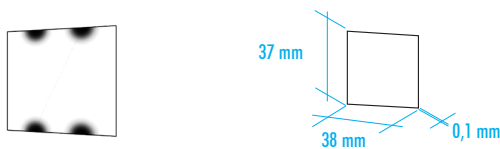

**ADHESIVE LABEL 80.80**

**GENERAL FEATURES**

To improve the light diffusion it is appropriate to use the adhesive to glue in the PCB supplied as accessory.



CODICE / CODE	COLORE / COLOUR	DESCRIZIONE/DESCRIPTION
P1400005E	-	Etichetta adesiva per 80.80 / Adhesive label for 80.80

<b>CONFEZIONE N° PCS/KIT:</b>	<b>100</b>
<b>PACKAGING N° PCS/KIT:</b>	<b>100</b>
<b>PESO DELLA CONFEZIONE:</b>	<b>0,18 kg</b>
<b>PACKAGING WEIGHT:</b>	<b>0,18 kg</b>

<b>MINIMO ACQUISTABILE:</b>	<b>1</b>
<b>MINIMUM ORDER:</b>	<b>1</b>
<b>PESO DEL PEZZO KIT:</b>	<b>0,8 g</b>
<b>KIT WEIGHT:</b>	<b>0,8 g</b>

**ETICHETTA ADESIVA 80.120**

**CARATTERISTICHE GENERALI**

Per migliorare la diffusione luminosa è opportuno utilizzare l'adesivo da incollare nel circuito stampato fornito come accessorio.

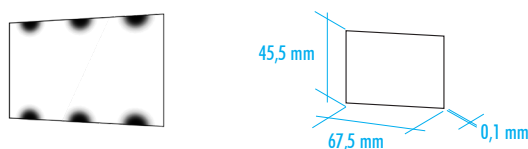

**ADHESIVE LABEL 80.120**

**GENERAL FEATURES**

To improve the light diffusion it is appropriate to use the adhesive to glue in the PCB supplied as accessory.



CODICE / CODE	COLORE / COLOUR	DESCRIZIONE/DESCRIPTION
P1400006E	-	Etichetta adesiva per 80.120 / Adhesive label for 80.120

<b>CONFEZIONE N° PCS/KIT:</b>	<b>100</b>
<b>PACKAGING N° PCS/KIT:</b>	<b>100</b>
<b>PESO DELLA CONFEZIONE:</b>	<b>0,2 kg</b>
<b>PACKAGING WEIGHT:</b>	<b>0,2 kg</b>

<b>MINIMO ACQUISTABILE:</b>	<b>1</b>
<b>MINIMUM ORDER:</b>	<b>1</b>
<b>PESO DEL PEZZO KIT:</b>	<b>1 g</b>
<b>KIT WEIGHT:</b>	<b>1 g</b>

## MASCHERA ASSEMBLAGGIO CARATTERISTICHE GENERALI

Materiale: ABS

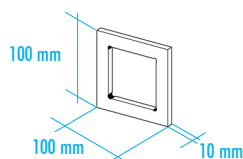

## ASSEMBLY MASK GENERAL FEATURES

Material: ABS



CODICE / CODE	COLORE / COLOUR	DESCRIZIONE/DESCRIPTION
14.MAS2000	Trasparente/Transparent	Maschera per assemblaggio vetro su Supporto in plastica 80.80 / Tools for glass assembly over Plastic support 80.80

CONFEZIONE N° PCS/KIT:	1
PACKAGING N° PCS/KIT:	1
PESO DELLA CONFEZIONE:	0,03 kg
PACKAGING WEIGHT:	0,03 kg

MINIMO ACQUISTABILE:	1
MINIMUM ORDER:	1
PESO DEL PEZZO KIT:	25 g
KIT WEIGHT:	25 g

## MASCHERA ASSEMBLAGGIO CARATTERISTICHE GENERALI

Materiale: ABS

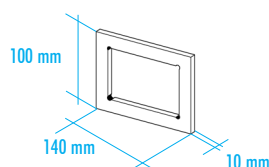

## ASSEMBLY MASK GENERAL FEATURES

Material: ABS



CODICE / CODE	COLORE / COLOUR	DESCRIZIONE/DESCRIPTION
14.MAS1000	Trasparente/Transparent	Maschera per assemblaggio vetro su Supporto in plastica 80.120 / Tools for glass assembly over Plastic support 80.120

CONFEZIONE N° PCS/KIT:	1
PACKAGING N° PCS/KIT:	1
PESO DELLA CONFEZIONE:	0,035 kg
PACKAGING WEIGHT:	0,035 kg

MINIMO ACQUISTABILE:	1
MINIMUM ORDER:	1
PESO DEL PEZZO KIT:	30 g
KIT WEIGHT:	30 g

## KIT CONTENITORE CARATTERISTICHE GENERALI

Materiale: ABS autoestinguente

Colore: Bianco

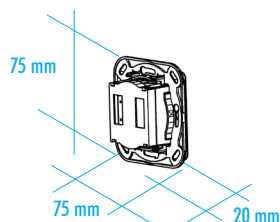

## KIT ENCLOSURE GENERAL FEATURES

Material: ABS self-extinguishing

Colour: White



CODICE / CODE	COLORE / COLOUR	DESCRIZIONE/DESCRIPTION
14.400011	Bianco/White	Kit contenitore, D60, 80.80, Tasti/Slider, H20 bianco / Kit Enclosure D60 80.80 Switches/Slider H20 White

CONFEZIONE N° PCS/KIT:	100
PACKAGING N° PCS/KIT:	100
PESO DELLA CONFEZIONE:	1,79 kg
PACKAGING WEIGHT:	1,79 kg

MINIMO ACQUISTABILE:	1
MINIMUM ORDER:	1
PESO DEL PEZZO KIT:	16 g
KIT WEIGHT:	16 g

## KIT CONTENITORE CARATTERISTICHE GENERALI

**Materiale:** ABS autoestinguente  
**Colore:** Bianco

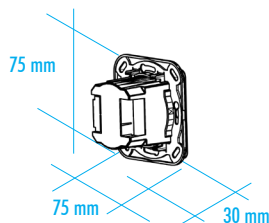
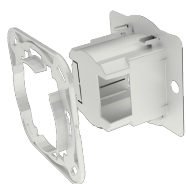

## KIT ENCLOSURE GENERAL FEATURES

**Material:** ABS self-extinguishing  
**Colour:** White



CODICE / CODE	COLORE / COLOUR	DESCRIZIONE/DESCRIPTION
14.400010	Bianco/White	Kit contenitore, D60, 80.80, Tasti/Slider, H30 bianco / Kit Enclosure D60 80.80 Switches/Slider H30 White

<b>CONFEZIONE N° PCS/KIT:</b>	<b>100</b>
<b>PACKAGING N° PCS/KIT:</b>	<b>100</b>
<b>PESO DELLA CONFEZIONE:</b>	<b>2,01 kg</b>
<b>PACKAGING WEIGHT:</b>	<b>2,01 kg</b>

<b>MINIMO ACQUISTABILE:</b>	<b>1</b>
<b>MINIMUM ORDER:</b>	<b>1</b>
<b>PESO DEL PEZZO KIT:</b>	<b>18 g</b>
<b>KIT WEIGHT:</b>	<b>18 g</b>

## KIT CONTENITORE CARATTERISTICHE GENERALI

**Materiale:** ABS autoestinguente  
**Colore:** Bianco

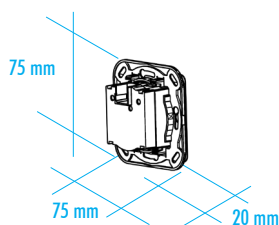
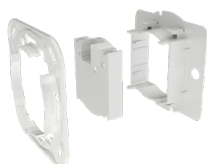

## KIT ENCLOSURE GENERAL FEATURES

**Material:** ABS self-extinguishing  
**Colour:** White



CODICE / CODE	COLORE / COLOUR	DESCRIZIONE/DESCRIPTION
14.400012	Bianco/White	Kit contenitore, D60, 80.80, Tasti/Slider, KNX H20 bianco / Kit Enclosure D60 80.80 Switches/Slider KNX H20 white

<b>CONFEZIONE N° PCS/KIT:</b>	<b>100</b>
<b>PACKAGING N° PCS/KIT:</b>	<b>100</b>
<b>PESO DELLA CONFEZIONE:</b>	<b>1,79 kg</b>
<b>PACKAGING WEIGHT:</b>	<b>1,79 kg</b>

<b>MINIMO ACQUISTABILE:</b>	<b>1</b>
<b>MINIMUM ORDER:</b>	<b>1</b>
<b>PESO DEL PEZZO KIT:</b>	<b>16 g</b>
<b>KIT WEIGHT:</b>	<b>16 g</b>

## KIT CONTENITORE CARATTERISTICHE GENERALI

**Materiale:** ABS autoestinguente  
**Colore:** Bianco

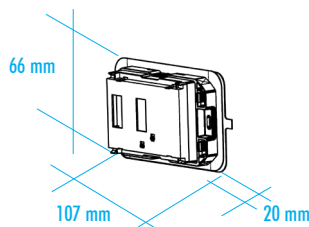
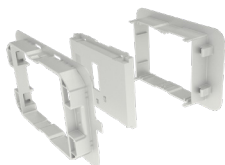

## KIT ENCLOSURE GENERAL FEATURES

**Material:** ABS self-extinguishing  
**Colour:** White



CODICE / CODE	COLORE / COLOUR	DESCRIZIONE/DESCRIPTION
14.400021	Bianco/White	Kit contenitore, 503, 80.120, Tasti/Slider, H20 bianco / Kit Enclosure 503 80.120 Switches/Slider H20 white

<b>CONFEZIONE N° PCS/KIT:</b>	<b>50</b>
<b>PACKAGING N° PCS/KIT:</b>	<b>50</b>
<b>PESO DELLA CONFEZIONE:</b>	<b>1,25 kg</b>
<b>PACKAGING WEIGHT:</b>	<b>1,25 kg</b>

<b>MINIMO ACQUISTABILE:</b>	<b>1</b>
<b>MINIMUM ORDER:</b>	<b>1</b>
<b>PESO DEL PEZZO KIT:</b>	<b>21 g</b>
<b>KIT WEIGHT:</b>	<b>21 g</b>

## KIT CONTENITORE CARATTERISTICHE GENERALI

**Materiale:** ABS autoestinguente  
**Colore:** Bianco

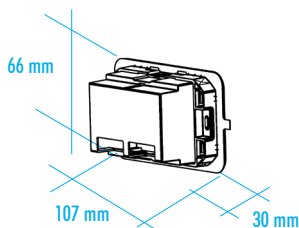
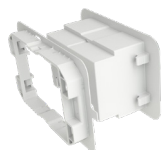

## KIT ENCLOSURE GENERAL FEATURES

**Material:** ABS self-extinguishing  
**Colour:** White



CODICE / CODE	COLORE / COLOUR	DESCRIZIONE/DESCRIPTION
14.4000020	Bianco/White	Kit contenitore, 503, 80.120, Tasti/Slider, H30 bianco/ Kit Enclosure 503 80.120 Switches/Slider H30 white

<b>CONFEZIONE N° PCS/KIT:</b>	<b>50</b>
<b>PACKAGING N° PCS/KIT:</b>	<b>50</b>
<b>PESO DELLA CONFEZIONE:</b>	<b>1,475 kg</b>
<b>PACKAGING WEIGHT:</b>	<b>1,475 kg</b>

<b>MINIMO ACQUISTABILE:</b>	<b>1</b>
<b>MINIMUM ORDER:</b>	<b>1</b>
<b>PESO DEL PEZZO KIT:</b>	<b>26 g</b>
<b>KIT WEIGHT:</b>	<b>26 g</b>

## KIT CONTENITORE CARATTERISTICHE GENERALI

**Materiale:** ABS autoestinguente  
**Colore:** Bianco

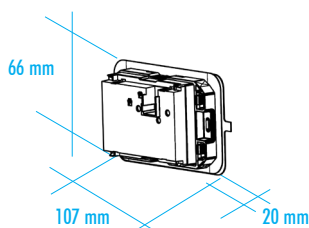
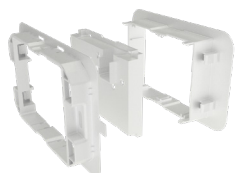

## KIT ENCLOSURE GENERAL FEATURES

**Material:** ABS self-extinguishing  
**Colour:** White



CODICE / CODE	COLORE / COLOUR	DESCRIZIONE/DESCRIPTION
14.4000024	Bianco/White	Kit contenitore, 503, 80.120, Tasti/Slider KNX H20 bianco / Kit Enclosure 503 80.120 Switches/Slider KNX H20 white

<b>CONFEZIONE N° PCS/KIT:</b>	<b>50</b>
<b>PACKAGING N° PCS/KIT:</b>	<b>50</b>
<b>PESO DELLA CONFEZIONE:</b>	<b>1,345 kg</b>
<b>PACKAGING WEIGHT:</b>	<b>1,345 kg</b>

<b>MINIMO ACQUISTABILE:</b>	<b>1</b>
<b>MINIMUM ORDER:</b>	<b>1</b>
<b>PESO DEL PEZZO KIT:</b>	<b>23 g</b>
<b>KIT WEIGHT:</b>	<b>23 g</b>

## VETRO CON GRAFICA SENZA BIADESIVO

### CARATTERISTICHE GENERALI

**Materiale:** Vetro temperato

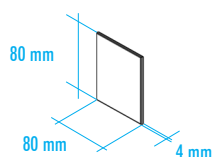

## GLASS GRAPHIC WITHOUT DOUBLE ADHESIVE

### GENERAL FEATURES

**Material:** Tempered glass



CODICE / CODE	DESCRIZIONE/DESCRIPTION
14.G222100	Vetro 80.80 con grafica tasti n.1 nero standard / 80.80 glass with graphic 1 switch standard black

<b>CONFEZIONE N° PCS/KIT:</b>	<b>50</b>
<b>PACKAGING N° PCS/KIT:</b>	<b>50</b>
<b>PESO DELLA CONFEZIONE:</b>	<b>3,2 kg</b>
<b>PACKAGING WEIGHT:</b>	<b>3,2 kg</b>

<b>MINIMO ACQUISTABILE:</b>	<b>1</b>
<b>MINIMUM ORDER:</b>	<b>1</b>
<b>PESO DEL PEZZO KIT:</b>	<b>60 g</b>
<b>KIT WEIGHT:</b>	<b>60 g</b>



## VETRO CON GRAFICA SENZA BIADESIVO

## GLASS GRAPHIC WITHOUT DOUBLE ADHESIVE

## CARATTERISTICHE GENERALI

Materiale: Vetro temperato

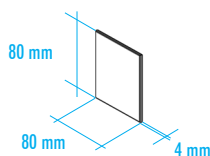
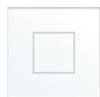

## CODICE / CODE DESCRIZIONE/DESCRIPTION

14.G211100 Vetro 80.80 con grafica tasti n.1 bianco standard / 80.80 glass with graphic 1 switch standard white

CONFEZIONE N° PCS/KIT:	50
PACKAGING N° PCS/KIT:	50
PESO DELLA CONFEZIONE:	3,2 kg
PACKAGING WEIGHT:	3,2 kg

MINIMO ACQUISTABILE:	1
MINIMUM ORDER:	1
PESO DEL PEZZO KIT:	60 g
KIT WEIGHT:	60 g

## VETRO CON GRAFICA SENZA BIADESIVO

## GLASS GRAPHIC WITHOUT DOUBLE ADHESIVE

## CARATTERISTICHE GENERALI

Materiale: Vetro temperato

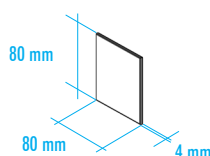

## CODICE / CODE DESCRIZIONE/DESCRIPTION

14.G222200 Vetro 80.80 con grafica tasti n.2 nero standard / 80.80 glass with graphic 2 switches standard black

CONFEZIONE N° PCS/KIT:	50
PACKAGING N° PCS/KIT:	50
PESO DELLA CONFEZIONE:	3,2 kg
PACKAGING WEIGHT:	3,2 kg

MINIMO ACQUISTABILE:	1
MINIMUM ORDER:	1
PESO DEL PEZZO KIT:	60 g
KIT WEIGHT:	60 g

## VETRO CON GRAFICA SENZA BIADESIVO

## GLASS GRAPHIC WITHOUT DOUBLE ADHESIVE

## CARATTERISTICHE GENERALI

Materiale: Vetro temperato

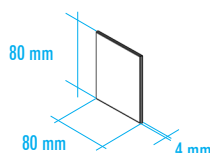

## CODICE / CODE DESCRIZIONE/DESCRIPTION

14.G211200 Vetro 80.80 con grafica tasti n.2 bianco standard / 80.80 glass with graphic 2 switches standard white

CONFEZIONE N° PCS/KIT:	50
PACKAGING N° PCS/KIT:	50
PESO DELLA CONFEZIONE:	3,2 kg
PACKAGING WEIGHT:	3,2 kg

MINIMO ACQUISTABILE:	1
MINIMUM ORDER:	1
PESO DEL PEZZO KIT:	60 g
KIT WEIGHT:	60 g

## VETRO CON GRAFICA SENZA BIADESIVO

## GLASS GRAPHIC WITHOUT DOUBLE ADHESIVE

## CARATTERISTICHE GENERALI

Material: Vetro temperato

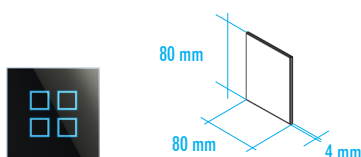

CODICE / CODE	DESCRIZIONE/DESCRIPTION
14.G222400	Vetro 80.80 con grafica tasti n.4 nero standard / 80.80 glass with graphic 4 switches standard black

CONFEZIONE N° PCS/KIT:	50
PACKAGING N° PCS/KIT:	50
PESO DELLA CONFEZIONE:	3,2 kg
PACKAGING WEIGHT:	3,2 kg

MINIMO ACQUISTABILE:	1
MINIMUM ORDER:	1
PESO DEL PEZZO KIT:	60 g
KIT WEIGHT:	60 g

## VETRO CON GRAFICA SENZA BIADESIVO

## GLASS GRAPHIC WITHOUT DOUBLE ADHESIVE

## CARATTERISTICHE GENERALI

Material: Vetro temperato

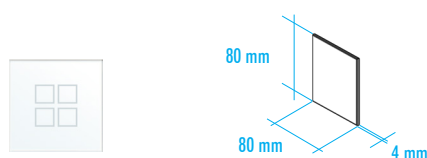

CODICE / CODE	DESCRIZIONE/DESCRIPTION
14.G211400	Vetro 80.80 con grafica tasti n.4 bianco standard / 80.80 glass with graphic 4 switches standard white

CONFEZIONE N° PCS/KIT:	50
PACKAGING N° PCS/KIT:	50
PESO DELLA CONFEZIONE:	3,2 kg
PACKAGING WEIGHT:	3,2 kg

MINIMO ACQUISTABILE:	1
MINIMUM ORDER:	1
PESO DEL PEZZO KIT:	60 g
KIT WEIGHT:	60 g

## VETRO CON GRAFICA SENZA BIADESIVO

## GLASS GRAPHIC WITHOUT DOUBLE ADHESIVE

## CARATTERISTICHE GENERALI

Material: Vetro temperato

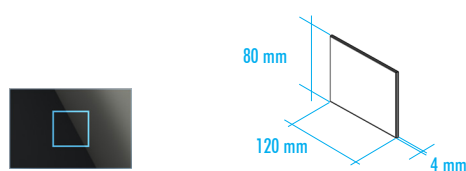

CODICE / CODE	DESCRIZIONE/DESCRIPTION
14.G122100	Vetro 80.120 con grafica tasti n.1 nero standard / 80.120 glass with graphic 1 switch standard black

CONFEZIONE N° PCS/KIT:	50
PACKAGING N° PCS/KIT:	50
PESO DELLA CONFEZIONE:	4,85 kg
PACKAGING WEIGHT:	4,85 kg

MINIMO ACQUISTABILE:	1
MINIMUM ORDER:	1
PESO DEL PEZZO KIT:	93 g
KIT WEIGHT:	93 g

VETRO CON GRAFICA SENZA BIADESIVO

GLASS GRAPHIC WITHOUT DOUBLE ADHESIVE

CARATTERISTICHE GENERALI

Material: Vetro temperato

GENERAL FEATURES

Material: Tempered glass  
Colour: White

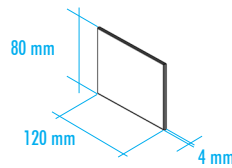

CODICE / CODE	DESCRIZIONE/DESCRIPTION
14.G111100	Vetro 80.120 con grafica tasti n.1 bianco standard / 80.120 glass with graphic 1 switch standard white

CONFEZIONE N° PCS/KIT:	50
PACKAGING N° PCS/KIT:	50
PESO DELLA CONFEZIONE:	4,85 kg
PACKAGING WEIGHT:	4,85 kg

MINIMO ACQUISTABILE:	1
MINIMUM ORDER:	1
PESO DEL PEZZO KIT:	93 g
KIT WEIGHT:	93 g

VETRO CON GRAFICA SENZA BIADESIVO

GLASS GRAPHIC WITHOUT DOUBLE ADHESIVE

CARATTERISTICHE GENERALI

Material: Vetro temperato

Material: Tempered glass

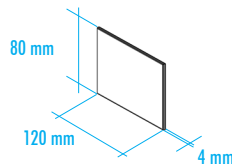

CODICE / CODE	DESCRIZIONE/DESCRIPTION
14.G122300	Vetro 80.120 con grafica tasti n.3 nero standard / 80.120 glass with graphic 3 switches standard black

CONFEZIONE N° PCS/KIT:	50
PACKAGING N° PCS/KIT:	50
PESO DELLA CONFEZIONE:	4,85 kg
PACKAGING WEIGHT:	4,85 kg

MINIMO ACQUISTABILE:	1
MINIMUM ORDER:	1
PESO DEL PEZZO KIT:	93 g
KIT WEIGHT:	93 g

VETRO CON GRAFICA SENZA BIADESIVO

GLASS GRAPHIC WITHOUT DOUBLE ADHESIVE

CARATTERISTICHE GENERALI

Material: Vetro temperato

Material: Tempered glass

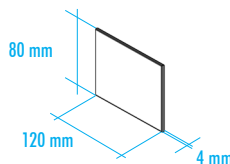

CODICE / CODE	DESCRIZIONE/DESCRIPTION
14.G111300	Vetro 80.120 con grafica tasti n.3 bianco standard / 80.120 glass with graphic 3 switches standard white

CONFEZIONE N° PCS/KIT:	50
PACKAGING N° PCS/KIT:	50
PESO DELLA CONFEZIONE:	4,85 kg
PACKAGING WEIGHT:	4,85 kg

MINIMO ACQUISTABILE:	1
MINIMUM ORDER:	1
PESO DEL PEZZO KIT:	93 g
KIT WEIGHT:	93 g

VETRO CON GRAFICA SENZA B.  
GLASS WITH GRAPHIC WITHOUT D.A.

## VETRO CON GRAFICA SENZA BIADESIVO

GLASS GRAPHIC WITHOUT DOUBLE  
ADHESIVE

## CARATTERISTICHE GENERALI

Materiale: Vetro temperato

## GENERAL FEATURES

Material: Tempered glass

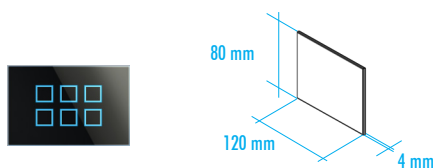

CODICE / CODE	DESCRIZIONE/DESCRIPTION
14.G122600	Vetro 80.120 con grafica tasti n.6 nero standard / 80.120 glass with graphic 6 switches standard black

CONFEZIONE N° PCS/KIT:	50
PACKAGING N° PCS/KIT:	50
PESO DELLA CONFEZIONE:	4,85 kg
PACKAGING WEIGHT:	4,85 kg

MINIMO ACQUISTABILE:	1
MINIMUM ORDER:	1
PESO DEL PEZZO KIT:	93 g
KIT WEIGHT:	93 g

## VETRO CON GRAFICA SENZA BIADESIVO

GLASS GRAPHIC WITHOUT DOUBLE  
ADHESIVE

## CARATTERISTICHE GENERALI

Materiale: Vetro temperato

## GENERAL FEATURES

Material: Tempered glass

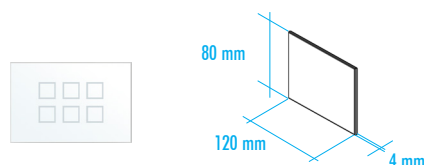

CODICE / CODE	DESCRIZIONE/DESCRIPTION
14.G111600	Vetro 80.120 con grafica tasti n.6 bianco standard / 80.120 glass with graphic 6 switches standard white

CONFEZIONE N° PCS/KIT:	50
PACKAGING N° PCS/KIT:	50
PESO DELLA CONFEZIONE:	4,85 kg
PACKAGING WEIGHT:	4,85 kg

MINIMO ACQUISTABILE:	1
MINIMUM ORDER:	1
PESO DEL PEZZO KIT:	93 g
KIT WEIGHT:	93 g

## SCATOLE

## CARATTERISTICHE GENERALI

Materiale: Cartone

Colore: Bianco

## BOXES

## GENERAL FEATURES

Material: Cardboard

Colour: White

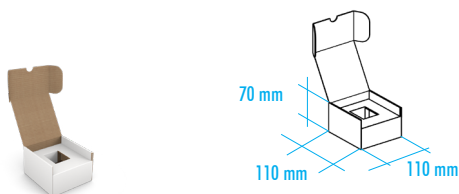

CODICE / CODE	DESCRIZIONE/DESCRIPTION
P14D00260P	Imballo per dispositivo iGlass 80x80 bianco 110x110x70mm / Packaging for DEVICE iGlass 80x80 white 110x110x70mm

CONFEZIONE N° PCS/KIT:	10
PACKAGING N° PCS/KIT:	10
PESO DELLA CONFEZIONE:	0,55 kg
PACKAGING WEIGHT:	0,55 kg

MINIMO ACQUISTABILE:	1
MINIMUM ORDER:	1
PESO DEL PEZZO KIT:	45 g
KIT WEIGHT:	45 g

**SCATOLE****CARATTERISTICHE GENERALI**

Materiale: Cartone

Colore: Bianco

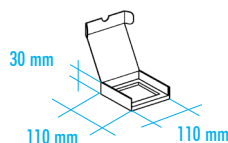
**CODICE / CODE DESCRIZIONE/DESCRIPTION**

P14C00260P Imballo per copriplacca iGlass 80x80 bianco 110x110x30mm  
Packaging for Cover Frame iGlass 80x80 white 110x110x30mm

**CONFEZIONE N° PCS/KIT:** 10  
**PACKAGING N° PCS/KIT:** 10

**PESO DELLA CONFEZIONE:** 0,5 kg  
**PACKAGING WEIGHT:** 0,5 kg

**MINIMO ACQUISTABILE:** 1  
**MINIMUM ORDER:** 1

**PESO DEL PEZZO KIT:** 40 g  
**KIT WEIGHT:** 40 g

**SCATOLE****CARATTERISTICHE GENERALI**

Materiale: Cartone

Colore: Bianco

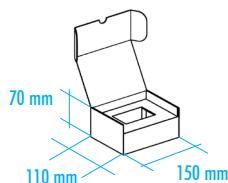
**CODICE / CODE DESCRIZIONE/DESCRIPTION**

P14D04503P Imballo per dispositivo iGlass 80x120 bianco 110x150x70mm  
Packaging for DEVICE iGlass 80x120 white 110x150x70mm

**CONFEZIONE N° PCS/KIT:** 10  
**PACKAGING N° PCS/KIT:** 10

**PESO DELLA CONFEZIONE:** 0,65 kg  
**PACKAGING WEIGHT:** 0,65 kg

**MINIMO ACQUISTABILE:** 1  
**MINIMUM ORDER:** 1

**PESO DEL PEZZO KIT:** 55 g  
**KIT WEIGHT:** 55 g

**SCATOLE****CARATTERISTICHE GENERALI**

Materiale: Cartone

Colore: Bianco

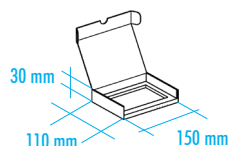
**CODICE / CODE DESCRIZIONE/DESCRIPTION**

P14C04503P Imballo per copriplacca iGlass 80x120 bianco 110x150x30mm  
Packaging for Cover Frame iGlass 80x120 white 110x150x30mm

**CONFEZIONE N° PCS/KIT:** 10  
**PACKAGING N° PCS/KIT:** 10

**PESO DELLA CONFEZIONE:** 0,55 kg  
**PACKAGING WEIGHT:** 0,55 kg

**MINIMO ACQUISTABILE:** 1  
**MINIMUM ORDER:** 1

**PESO DEL PEZZO KIT:** 45 g  
**KIT WEIGHT:** 45 g

## ASSEMBLAGGIO

## ASSEMBLY

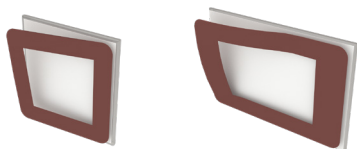

CODICE / CODE	COLORE / COLOUR	DESCRIZIONE/DESCRIPTION
14.TAV30SP	-	Assemblaggio biadesivo su vetro/ Double sided adhesive assembly on glass

## ASSEMBLAGGIO

## ASSEMBLY

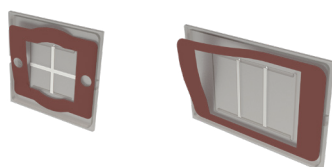

CODICE / CODE	COLORE / COLOUR	DESCRIZIONE/DESCRIPTION
14.TAV40SP	-	Assemblaggio biadesivo su supporto/Double sided adhesive assembly on support

## ASSEMBLAGGIO

## ASSEMBLY

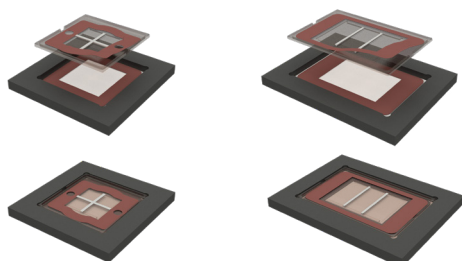

CODICE / CODE	COLORE / COLOUR	DESCRIZIONE/DESCRIPTION
14.TAV10SP	-	Assemblaggio vetro con Biadesivo su supporto/Glass assembly with Double sided adhesive on support

SCATOLE ELETTRICHE COMPATIBILI  
iGLASS 80.80

ELECTRICAL ENCLOSURE USE FOR  
iGLASS 80.80



VIMAR V71601



SCHNEIDER IMT 35001



VIMAR V71701



SCHNEIDER IMT 35032



BTICINO PB502



SPELSBERG 92005001



LEGRAND 800 51



SPELSBERG 92003501  
(solo versione H20/Only version H20)



LEGRAND 800 41  
(solo versione H20/Only version H20)



SIB P16840  
(solo versione H20/Only version H20)



LEGRAND 801 21



KAISER 9063-01



LEGRAND 800 31  
(solo versione H20/Only version H20)



F-TRONIC E-115

iGlass



BTICINO PB503

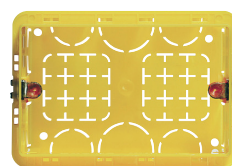

BTICINO 503E



VIMAR V71703



VIMAR V71303



GEWISS GW24403PM



GEWISS GW24403



AVE 253CG



## FINISHING SERVICE

ITALTRONIC è da tempo impegnata nella fornitura dei propri contenitori completi di servizi aggiuntivi vari per il completamento dei prodotti esteticamente e meccanicamente. Per fare ciò si è dotato di un ufficio tecnico che può tradurre le note della clientela in disegni esecutivi prima e in campionature per la valutazione finale della corrispondenza al progetto.

Alcuni servizi sono completamente GRATUITI, cioè quando il cliente fornisce dei documenti tecnici già conformi al post process che ITALTRONIC dovrà fare, altri invece sono a pagamento: generalmente quando ITALTRONIC deve sviluppare un progetto sui propri contenitori oppure adattare le informazioni ricevute agli STANDARD necessari per avviare la produzione.

Qui di seguito troverete una semplice traccia di quelle che sono le richieste minime di ITALTRONIC affinché la gestione possa essere veloce, semplice e gratuita, fatto salvo i costi di attrezzatura di base; altrimenti saranno addebitati i costi relativi alle attività svolte dai tecnici ITALTRONIC al puro costo aziendale.

### PERSONALIZZAZIONE MECCANICA

Siamo in grado di fornire un servizio di personalizzazione meccanica del prodotto con l'ausilio di macchine per fresatura CNC, taglio e tranciatura.

**Lavorazioni meccaniche su superfici:** ABS, PC/ABS, PPO, PC, PMMA, PA

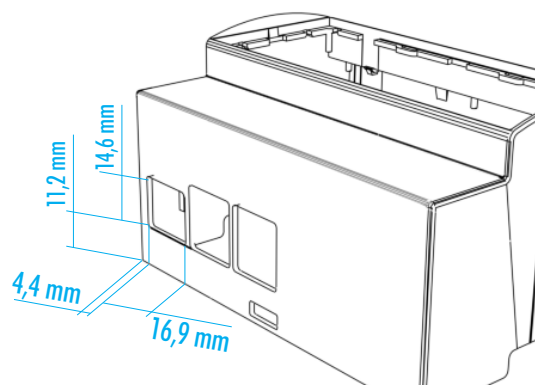

### SPECIFICHE TECNICHE RICHIESTE

**File:** .dwg, .dxf o STEP

**Dimensioni:** Scala 1:1

In caso contrario, verranno addebitati i costi in base alla complessità nel creare un file di lavorazione. Come modello per la creazione di un file abbiamo bisogno di un disegno/schizzo che contenga tutte le dimensioni di lavorazione pertinenti.

EXTRA COST



OK



EXTRA COST



### SPECIFICHE TECNICHE GARANTITE

**Centraggio delle lavorazioni**

La centatura di tutte le lavorazioni eseguite da Italtronic è sottoposta a un controllo finale con uno strumento semplice come il calibro.

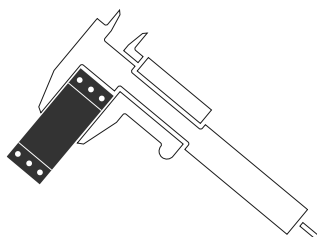

## FINISHING SERVICE

For years ITALTRONIC has been working to supply its enclosures with the various additional services to complete the products both externally and mechanically. To do this, we have set up our technical office that is able to translate our customers' notes into initial project drawings and samples to enable a final evaluation of whether they correspond to the project.

Some services are FREE OF CHARGE, i.e. when the customer gives us the technical documents that already conform to the post processing ITALTRONIC has to do, while others are for a fee: usually when ITALTRONIC has to develop a project on its own enclosures, or adapt the information received to the necessary production STANDARDS.

Below you will find a simple guide of the ITALTRONIC minimum requests so that the process can be quick, simple and free, apart from the basic equipment costs, otherwise we will charge you for the work of our ITALTRONIC technicians at the pure cost price.

### MECHANICAL PERSONALIZATION

We can supply a product mechanical personalization service with the aid of milling, CNC, cutting and trenching machines.

**Mechanical processing:** on ABS, PC/ABS, PPO, PC, PMMA, PA surfaces

### TECHNICAL SPECS REQUEST

**File:** .dwg, .dxf o STEP

**Dimensions:** 1:1 scale

Otherwise, additional costs will be charged, according to the complexity of the print file preparation. As guideline for the final print file, we need to have a drawing / sketch showing all pertinent working dimensions.

## COME QUOTARE E CONTROLLARE LE MISURE DELLE LAVORAZIONI

Qui sotto riportiamo un esempio di come possono essere eseguite delle misure affinché risultino centrate con altri processi, come quello di STAMPA, e siano ortogonali ai piani di riferimento dei nostri prodotti.

## HOW TO QUOTE AND TO CHECK THE MACHINING DIMENSIONS

Below is an example of how the measurements can be taken so that they are centred with other processes, such as PRINT, and are at right angles to the reference surfaces of our products.

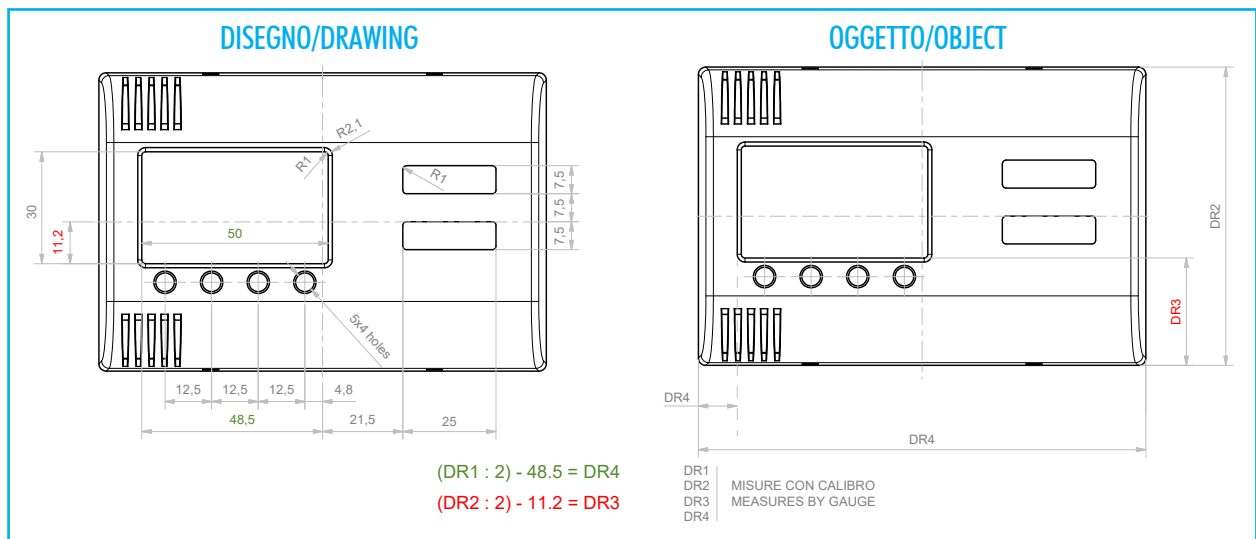

## SVASATURE E RIBASSI

ITALTRONIC offre un ottimo servizio di finitura meccanica adatta a migliorare l'estetica del prodotto, con svasature e ribassi.

## FLARING & LOWERING

ITALTRONIC offers a very good mechanical Finishing Service for a better aesthetics result of the products, with flaring and lowering.

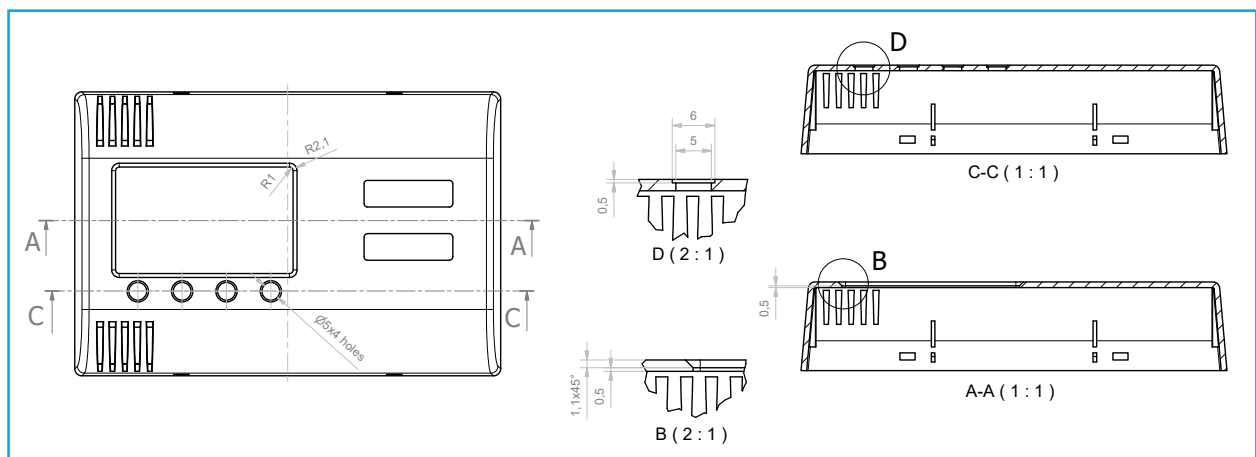

Le tolleranze dimensionali possono essere ristrette se indicate nel disegno del cliente e se compatibili con i nostri processi produttivi: la fornitura del nostro disegno controfirmata fa da garanzia.

The size tolerances can be less if they are indicated in the customer's drawing and are compatible with our production processes: the supply of our countersigned drawing guarantees this.

## Tolleranze dimensionali/Tolerance limits

Secondo tolleranze generali UNI EN 22768/1 media (m):

Average tolerances as per UNI EN 22768/1 medium (m):

DA 0.5 A 3 mm/FROM 0.5 TO 3mm	±0.1 mm
DA 3 FINO A 6 mm/FROM 3 TO 6mm	±0.1 mm
OLTRE 6 FINO A 30 mm/BEYOND 6 AND UP TO 30 mm	±0.2 mm
OLTRE 30 FINO A 120 mm/BEYOND 30 AND UP TO 120 mm	±0.3 mm
OLTRE 120 FINO A 400 mm/BEYOND 120 AND UP TO 400 mm	±0.5 mm

**PERSONALIZZAZIONE GRAFICA**

ITALTRONIC fornisce un ottimo servizio di personalizzazione grafica sui propri prodotti. È opportuno prendere visione delle note più sotto per ottenere risposte veramente veloci e costi ridotti al minimo.

**Nota:** Tutti i contenuti devono essere modificabili (generalmente i file non vettoriali non sono modificabili)

In caso contrario, verranno addebitati i costi in base alla complessità nel creare un file di stampa. Per la creazione di un file di stampa a partire da zero abbiamo bisogno di un disegno / schizzo che contenga tutte le dimensioni di lavorazione pertinenti. Se non è possibile fornire i loghi, i simboli (come file di immagine, ad es. Jpg con risoluzione min. 1200 dpi) o eventuali caratteri speciali, sono possibili lievi non conformità.

**DOCUMENTAZIONE TECNICA RICHIESTA DA ITALTRONIC**

**File di stampa ottimale:** layout deve sempre essere una grafica vettoriale (no grafica raster) in formato Adobe Illustrator, EPS, file .pdf vettoriale o Corel Draw.

**GRAPHIC PERSONALIZATION**

ITALTRONIC provides an excellent customised graphic service on its products. Read the notes below for a quick answer and costs reduced to the minimum.

**Note:** All contents must be editable (non-vector files usually cannot be modified)

Otherwise, additional costs will be charged, according to the complexity of the print file preparation. In order to create a print file from scratch, we need to have a drawing / sketch showing all pertinent working dimensions. If it is not possible to supply logos, symbols (in image-format files, such as jpg, with a minimum resolution of 1200 dpi) as well as any special non-standard characters, slight differences should be expected.

**TECHNICAL DOCUMENTATION REQUIRED BY ITALTRONIC**

**Optimal print file:** the layout must always be a vector graphic (no raster graphic) in Adobe Illustration EPS format, vector PDF or Corel Draw.

EXTRA COST



OK

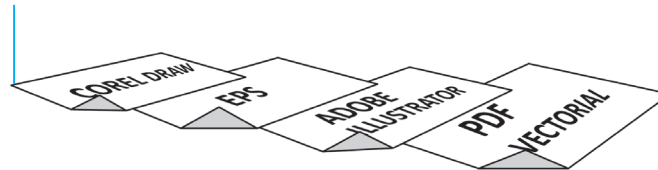

EXTRA COST

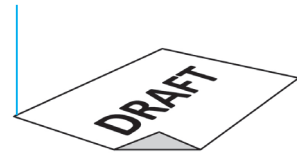

Nel caso in cui parte del file (o tutto il file non sia vettoriale, potremo accettare file con le caratteristiche: scala 1:1, inclusi file di immagine, ad esempio jpg o bmp risoluzione minima 1200 dpi.

In case part of the file (or the entire file) is not a vector graphic, we may consider files having the following characteristics: scale 1:1, including image files such as jpg or bmp, 1200 dpi minimal resolution.



**Nota:** Esempio file immagine alta risoluzione (1200 dpi)  
**Note:** High resolution image file example (1200 dpi)

**Nota:** Esempio file immagine bassa risoluzione (< 1200 dpi)  
**Note:** Low resolution image file example (< 1200 dpi)

**SPECIFICHE TECNICHE GARANTITE**

**CENTRAGGIO DELLE STAMPE**

La centratura di tutte le lavorazioni eseguite da ITALTRONIC è sottoposta a un controllo finale con uno strumento semplice come il calibro.

Qui sotto riportiamo un esempio di come possono essere eseguite delle misure affinché risultino centrate con altri processi, come quello di CNC, e siano ortogonali ai piani di riferimento dei nostri prodotti.

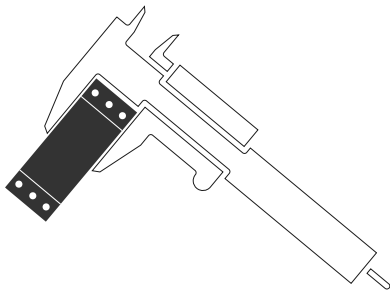

Le tolleranze possono essere ristrette se indicate nel disegno del cliente e se compatibili con i nostri processi produttivi: la fornitura del nostro disegno controfirmato fa da garanzia.

**GUARANTED TECHNICAL SPECS**

**PRINTING CENTRING**

The centring for all the work by Italtronic undergoes a final control using a simple tool, like a gauge.

Below is an example of how the measurements can be taken so that they are centred with other processes, such as CNC, and are at right angles to the reference surfaces of our products.

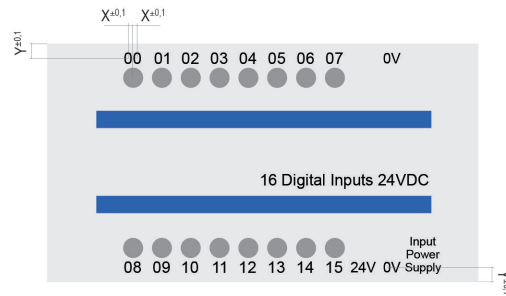

The size tolerances can be less if they are indicated in the customer's drawing and are compatible with our production processes: the supply of our countersigned drawing guarantees this.

**Tolleranze dimensionali/Tolerance limits**

Con stampa di forma (mm) secondo tolleranze generali UNI EN 22768/1 media (m):

With dye (mm) printing having average tolerances as per UNI EN 22768/1 medium (m):

DA 0.5 A 3 mm/FROM 0.5 TO 3 mm	±0.1 mm
DA 3 FINO A 6 mm/FROM 3 TO 6 mm	±0.1 mm
OLTRE 6 FINO A 30 mm/BEYOND 6 AND UP TO 30 MM	±0.2 mm
OLTRE 30 FINO A 120 mm/BEYOND 30 AND UP TO 120 mm	±0.3 mm
OLTRE 120 FINO A 400 mm/BEYOND 120 AND UP TO 400 mm	±0.5 mm
<b>VARIAZIONI PERMESSE/PERMITTED VARIATIONS</b>	Ampiezza della linea ± 10%/Line extent ± 10%
<b>TOLLERANZA DI SPAZI VUOTI/EMPTY SPACE TOLERANCE</b>	Contorno esterno e ritagli (mm) ± 0.3*/External contour and cropping (mm) ± 0.3*

## STAMPA DIGITALE

La stampa digitale è particolarmente indicata quando sono richiesti molti colori, sfumature e tempi rapidi di esecuzione con costi contenuti; per quantità da basse a medio alte.

Il processo di stampa digitale UV con qualità fotografica permette facilmente di poter avere la massima flessibilità per realizzare qualsiasi tipo di grafica a più colori ad un prezzo competitivo anche per piccoli lotti.

Si tratta di una stampa in quadricromia a getto d'inchiostro successivamente catalizzata a mezzo UV, con una dimensione dei pixel molto ridotta che però non consente di ottenere esattamente la tonalità di colore richiesta (scala RAL o PANTONE).

### SPECIFICHE TECNICHE:

**Superfici:** Stampa su ABS, PC/ABS, PPO, PC, PMMA, PA

**Profondità massima:** 1,5 mm

**Colori:** CMYK + bianco

**Risoluzione:** fino a 1440x1200 dpi

**Formato massimo di stampa:** 297x420 mm



## STAMPA TAMPOGRAFICA

La stampa tampografica è consigliata quando è sufficiente un solo colore e la profondità (scalino) di stampa è superiore a 1,5 mm.

È un procedimento di stampa indiretto, che permette di riprodurre, in modo semplice con elevata fedeltà e risoluzione disegni, scritte e decori sia su superfici piane che su superfici concave, convesse o comunque irregolari. Consigliamo l'impiego di questa tecnologia fino ad un massimo di 2 colori (esempio pannello a 1 o 2 colori) su nostri coprimorsetti, contenitori e anche pannelli.

### SPECIFICHE TECNICHE:

**Superfici:** Stampa su ABS, PC/ABS, PPO, PC, PMMA, PA

**Colori:** Tutti

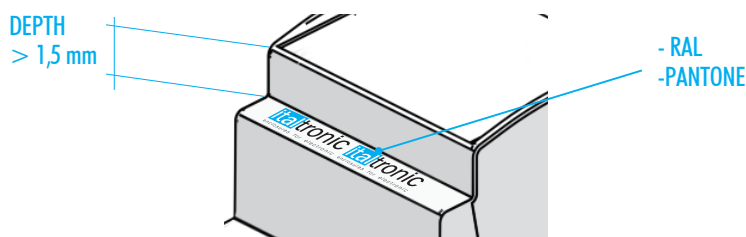

## STAMPA SERIGRAFICA

È una tecnologia consolidata di stampa industriale, molto utilizzata in tutte le applicazioni in cui sia richiesto un deposito di inchiostro più elevato rispetto ad altre tecnologie di stampa su superfici piane. Il principio per cui una raclea spingendo un inchiostro o una pasta attraverso una maglia aperta di un tessuto tecnico ne ottiene un passaggio uniforme e controllato.

### SPECIFICHE TECNICHE:

**Superfici:** Stampa su ABS, PC/ABS, PPO, PC, PMMA, PA

**Colori:** Tutti

## MARCATURA LASER

Consente l'identificazione permanente (monocromatica) del prodotto anche con tratti molto sottili.

### SPECIFICHE TECNICHE:

**Superfici:** Stampa su ABS, PC/ABS, PPO

**Colori:** Colore a contrasto a seconda del tipo di materiale

## DIGITAL PRINT

Digital printing is ideal when a lot of colours are involved, with shading and fast production with limited costs; for small, medium and large quantities.

The UV digital print process with photographic quality allows maximum flexibility in the realization of any type of graphic in several colours and at a very competitive price, even for small quantities.

It is an inkjet four-colour printing method subsequently catalysed by UV, with a consistently reduced pixel size which, on the other hand, does not guarantee exact colour tonality reproduction (RAL table or pantone).

### TECHNICAL SPECS:

**Surfaces:** Print on ABS, PC/ABS, PPO, PC, PMMA, PA

**Maximum depth:** 1,5 mm

**Colours:** CMYK + white

**Resolution:** up to 1440x1200 dpi

**Maximum print size:** 297x420 mm

## PAD PRINTING

Pad printing is recommended when just one colour is sufficient and the printing depth (step) is more than 1.5 mm.

It is an indirect printing process, which allows reproducing high-fidelity and high resolution drawings, writings and decors, on either flat, concave, convex or anyway irregular surfaces. We suggest this technology for prints up to 2 colour (e.g. a panel in 1 or 2 colours) on our terminal covers, containers and panels, too.

### TECHNICAL SPECS:

**Surfaces:** Print on ABS, PC/ABS, PPO, PC, PMMA, PA

**Colours:** All

## SERIGRAPHY PRINTING

It is a consolidated industrial print system, very much used in all applications requiring thicker ink layers in comparison with other flat-surface print technologies. The principle consists in a blade pushing the ink or paste through hollow tangles of technical fabrics, obtaining a controlled and uniform result.

### TECHNICAL SPECS:

**Surfaces:** Print on ABS, PC/ABS, PPO, PC, PMMA, PA

**Colours:** all

## LASER ENGRAVING

Allows permanent identification (monochrome) of the product, even with very thin strokes.

### TECHNICAL SPECS:

**Surfaces:** Print on ABS, PC/ABS, PPO

**Colours:** Contrasting colour depending on the material type

## Riproducibilità del colore/Colour reproducibility

	SERIGRAFIA/SERIGRAPHY	TAMPOGRAFIA/PAD-PRINTING	DIGITALE/ DIGITAL
FEDELTA' / FIDELITY	90%	90%	100%
COLORE CAMPIONE/SAMPLE COLOUR	100%	100%	60%

# Note

iGlass

A series of horizontal dashed lines for writing notes.





**italtronic**  
enclosures for electronics

**Italtronic Srl**

Corso Stati Uniti 17

35127 Padova - Italy

T. +39 049 8947150

F. +39 049 8947151

[www.italtronic.com](http://www.italtronic.com)

