

## Optional Function Modules

### Modules for ZMI and ZD sockets

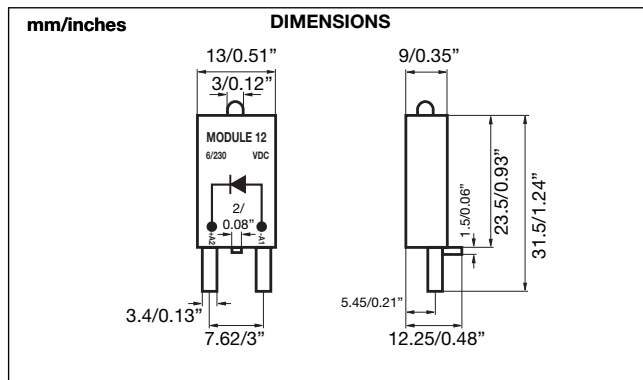

### Approvals

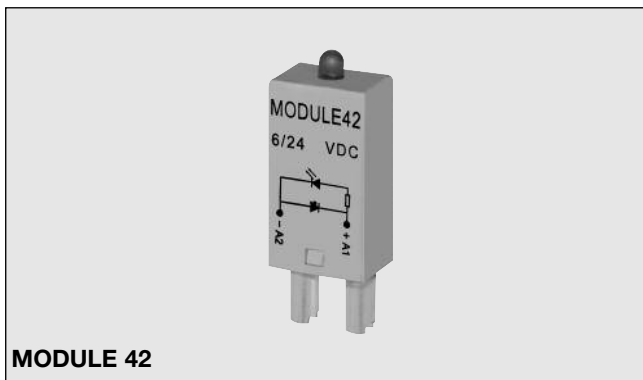

### General data

Module material	PA66+GF (V0)
Module colour	RAL 7035 / Pantone 1C

#### Packaging

Box content: 1 bag, 100pcs.  
 Box size: W 160 x D 70 x H 80 mm Weight: ~350g  
 (W 6.30 x D 2.75 x H 3.15) inches Weight: ~12.3oz

### Modules for ZPD sockets

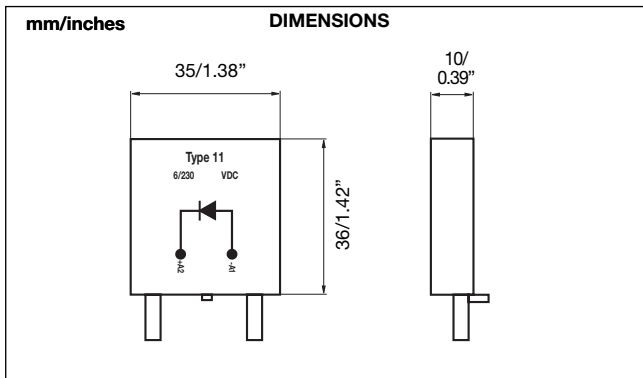
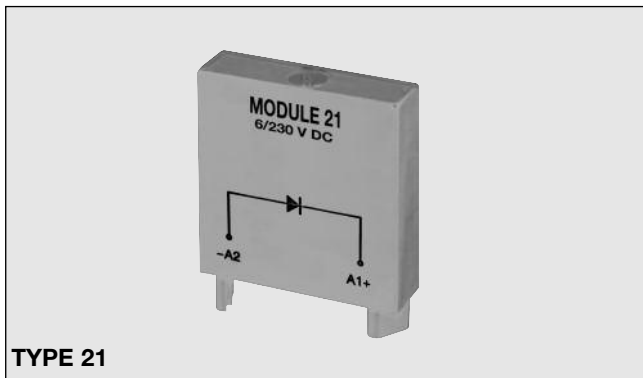

### Approvals



### General data

Module material	PA66+GF (V0)
Module colour	RAL 7035 / Pantone 1C

#### Packaging

Box content: 1 bag, 20pcs  
 Weight: ~150g (5.29oz)

## Types and electrical configurations

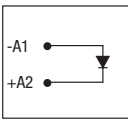
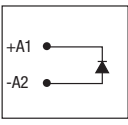
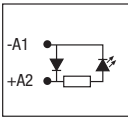
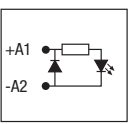
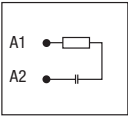
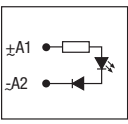
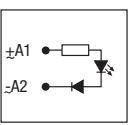
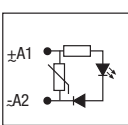
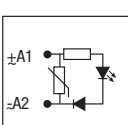
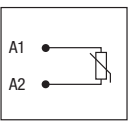
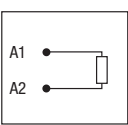
Diagram	Type	Description	Operating voltage	LED Colour	Ordering code		Notes
					ZMI, ZD, ZDM Sockets	ZPD9, ZPD11	
	12	Free wheeling diode A2 +	6 / 230VDC	n.a.	MODULE12	MODULE11	Only for DC relays
	22	Free wheeling diode A1 +	6 / 230VDC	n.a.	MODULE22	MODULE21	
	32	Free wheeling diode A2 +, with LED	6 / 24VDC	Red	MODULE32	n.a.	
			24 / 60VDC		MODULE32B		
			110 / 230VDC		MODULE32C		
			6 / 24VDC	Green**	MODULE32/G		
			24 / 60VDC		MODULE32B/G		
			110 / 230VDC		MODULE32C/G		
	42	Free wheeling diode A1 +, with LED	6 / 24VDC	Red	MODULE42		
			24 / 60VDC		MODULE42B		
			110 / 230VDC		MODULE42C		
			6 / 24VDC	Green**	MODULE42/G		
			24 / 60VDC		MODULE42B/G		
			110 / 230VDC		MODULE42C/G		
	52	RC Filter	110/240VAC	n.a.	MODULE52	MODULE51	Only for AC relays
		RC Filter	6 / 24VAC		MODULE52B	MODULE51B	
		RC Filter	24 / 60VAC		MODULE52D	MODULE51D	
	62	Signalling LED	6 / 24V	Red	MODULE62	n.a.	Can work with AC and DC Relays
	92		24 / 60V		MODULE62E		
			110 / 230V		MODULE92		
	62	Signalling LED	6 / 24V	Green**	MODULE62/G		
	92		24 / 60V		MODULE62E/G		
			110 / 230V		MODULE92/G		
	62	Signalling LED, with Varistor	6 / 24V	Red	MODULE62C		
	92		24 / 60V		MODULE62D		
			110 / 230V		MODULE92C		
	62	Signalling LED, with Varistor	6 / 24V	Green**	MODULE62C/G		
	92		24 / 60V		MODULE62D/G		
			110 / 230V		MODULE92C/G		
	72	Varistor	6 / 24VAC	n.a.	MODULE72	MODULE71	
	82		115VAC		MODULE72A	MODULE71A	
			230VAC		MODULE82	MODULE81	
	102	Resistor	110 / 230VAC	n.a.	MODULE102	n.a.	

\*\* Non standard devices normally not in stock and production upon request